



Owner's Manual

 **WARNING**

This User's Manual contains safety information and instructions for your trailer.

You must read this manual before loading or towing your trailer.

You must follow all safety precautions and instructions.

p: 574 848 5665

tf: 877 475 LOOK (5665)

fx: 574 848 5660

www.paceamerican.com

11550 Harter Drive Middlebury, IN 46540

7-way RV Style Trailer Plug Wiring (aka Pollock or Bargman plug)

Truck

(view looking into connector)

Trailer

(view looking at end of plug)

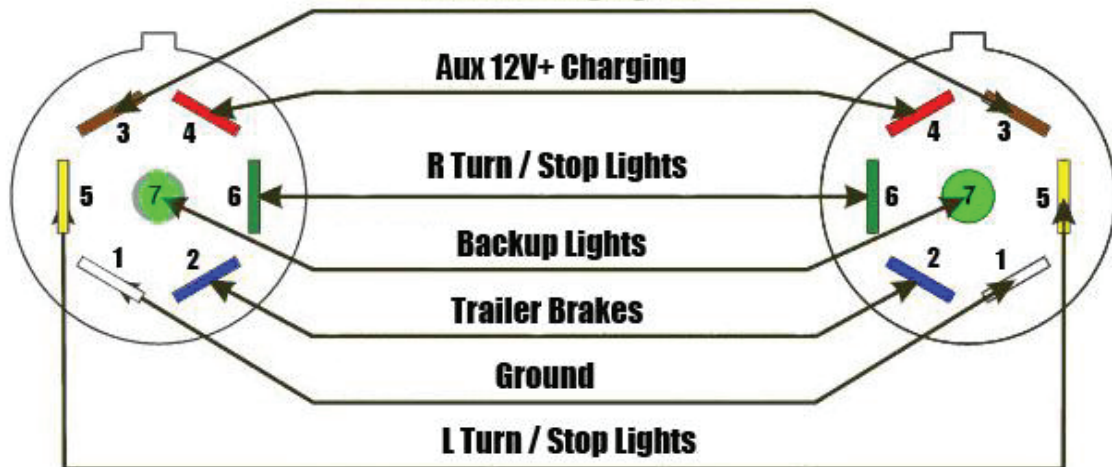

7-Pin RV flat blade

Car End



CAUTION:
Locate wires by
function only.
Color coding is **not**
standard
among all
manufacturers.

Trailer End



4-WAY PLUG TRAILER END

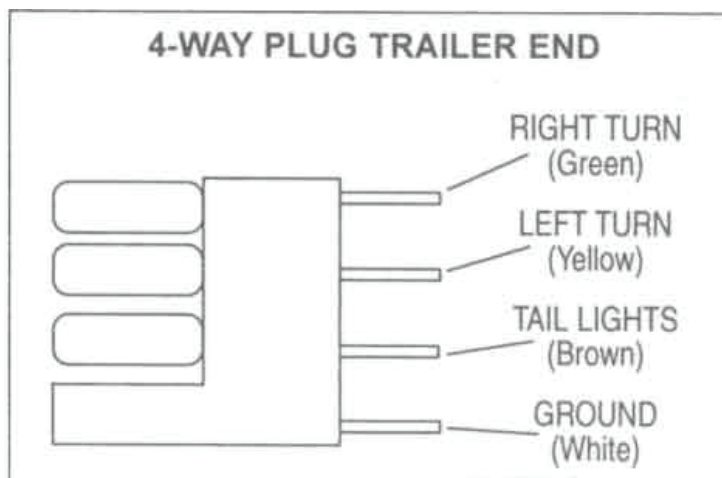



 **WARNING**

This User's Manual contains safety information and instructions for your trailer.

You must read this manual before loading or towing your trailer.

You must follow all safety precautions and instructions.

Pace American
877-465-LOOK (5665) Phone
574-848-5660 Fax
11550 Harter Drive
Middlebury, IN 46540

Our Mission:

LOOK Trailers is a family-focused company; building industry-leading products while making safety, innovation and customer service our highest priorities.

1. GENERAL SAFETY INFORMATION	1
1.1. SAFETY ALERT SYMBOLS AND SIGNAL WORDS	1
1.2. MAJOR HAZARDS	1
1.2.1. <i>Improper Sizing of the Trailer to the Tow Vehicle</i>	2
1.2.2. <i>Driving Too Fast</i>	2
1.2.3. <i>Failure to Adjust Driving Behavior When Towing a Trailer</i>	2
1.2.4. <i>Trailer Not Properly Coupled to the Hitch</i>	3
1.2.5. <i>Proper Use of Safety Chains</i>	3
1.2.6. <i>Proper Connection of Breakaway Brake</i>	4
1.2.7. <i>Matching Trailer and Hitch</i>	4
1.2.8. <i>Worn Tires, Loose Wheels and Lug Nuts</i>	4
1.2.9. <i>Improper Loading</i>	5
1.2.10. <i>Unsafe Load Distribution</i>	6
1.2.11. <i>Shifting Cargo</i>	7
1.2.12. <i>Inappropriate Cargo</i>	7
1.2.13. <i>Inoperable Brakes, Lights or Mirrors</i>	8
1.2.14. <i>Hazards From Modifying Your Trailer</i>	8
1.2.15. <i>Hazards from Accessories</i>	9
1.2.15.1. Generator	9
1.2.15.2. Shore Power	9
1.2.15.3. LP Gas Fuel System	10
1.2.15.4. Fenders	10
1.2.15.5. Refueling Station	11
1.2.15.6. Trailer Roof	11
1.2.16. <i>Safety Warning Labels on Your Trailer</i>	11
1.2.17. <i>Trailer Towing Guide</i>	12
1.2.18. <i>Reporting Safety Defects</i>	12
1.2.19. <i>Warranty Claims</i>	13
1.3. SAFE TRAILER TOWING GUIDELINES	13
2. TIRE SAFETY INFORMATION	15
2.1. STEPS FOR DETERMINING CORRECT LOAD LIMIT – TRAILER	15
2.1.1. <i>Trailers 10,000 Pounds GVWR or Less</i>	15
2.1.2. <i>Trailers Over 10,000 Pounds GVWR (Note: These trailers are not required to have a tire information placard on the vehicle)</i>	16
2.2. STEPS FOR DETERMINING CORRECT LOAD LIMIT – TOW VEHICLE	16
2.3. TIRE SAFETY - EVERYTHING RIDES ON IT	16
2.3.1. <i>Safety First–Basic Tire Maintenance</i>	17
2.3.2. <i>Finding Your Vehicle’s Recommended Tire Pressure and Load Limits</i>	17
2.3.3. <i>Understanding Tire Pressure and Load Limits</i>	17
2.3.4. <i>Checking Tire Pressure</i>	17
2.3.5. <i>Steps for Maintaining Proper Tire Pressure</i>	17
2.3.6. <i>Tire Size</i>	18
2.3.7. <i>Tire Tread</i>	18
2.3.8. <i>Tire Balance and Wheel Alignment</i>	18
2.3.9. <i>Tire Repair</i>	18
2.3.10. <i>Tire Fundamentals</i>	18
2.3.10.1. Information on Passenger Vehicle Tires	19

2.3.10.2.	UTQGS Information.....	20
2.3.10.3.	Additional Information on Light Truck Tires	20
2.3.11.	<i>Tire Safety Tips</i>	21
3.	COUPLING TO THE TOW VEHICLE.....	22
3.1.	USE AN ADEQUATE TOW VEHICLE AND HITCH	22
3.1.1.	<i>Trailer Information</i>	23
3.1.1.1.	Certification/VIN Label.....	23
3.1.1.2.	Certification/VIN Label Safety Information	24
3.2.	COUPLING AND UNCOUPLING THE TRAILER.....	24
3.2.1.	<i>Various Coupler Designs</i>	25
3.2.2.	<i>Trailer with Ball-Hitch Coupler</i>	25
3.2.2.1.	Before coupling the trailer to the tow vehicle.....	26
3.2.2.2.	Before attempting to tow the trailer.....	26
3.2.2.3.	Prepare the coupler and hitch.....	27
3.2.2.4.	Couple the trailer to the tow vehicle.....	27
3.2.2.5.	Adjust hitch height	28
3.2.2.6.	Rig the safety chains	29
3.2.2.7.	Attach and test electric breakaway brake system.....	29
3.2.2.8.	Connect the electrical cables.....	30
3.2.2.9.	Uncoupling the Ball Hitch Trailer with Tongue Jack	31
3.2.3.	<i>Trailer with Gooseneck Coupler and Drop-leg Jack</i>	31
3.2.3.1.	Prepare the ball receiver and gooseneck ball.....	33
3.2.3.2.	Couple the trailer to the tow vehicle.....	33
3.2.3.3.	Rig the safety chains	34
3.2.3.4.	Attach and test the breakaway brake system.....	35
3.2.3.5.	Before attempting to tow the trailer.....	36
3.2.3.6.	Connect the electrical cables.....	36
3.2.3.7.	Uncoupling the Gooseneck Trailer with Drop-leg Jack	36
3.2.4.	<i>Trailer with Fifth-wheel Coupler and Drop-leg Jack</i>	37
3.2.4.1.	Before attempting to tow the trailer.....	37
3.2.4.2.	Raise the Drop Leg Jack	39
3.2.4.3.	Attach and test the breakaway brake system.....	40
3.2.4.4.	Connect the electrical cables.....	40
3.2.4.5.	Uncoupling the Fifth-Wheel Trailer with Drop-leg Jack.....	40
4.	LOADING THE TRAILER	42
4.1.	TONGUE WEIGHT	42
4.2.	CHECKING TONGUE WEIGHT	42
4.3.	SECURING THE CARGO.....	44
4.3.1.	<i>Loading Cargo (Enclosed Trailer)</i>	44
4.3.1.1.	Preparing the Trailer for Loading	44
4.3.1.2.	Loading the Enclosed Trailer	44
5.	CHECKING THE TRAILER BEFORE AND DURING EACH TOW	46
5.1.	PRE-TOW CHECKLIST	46
5.2.	MAKE REGULAR STOPS	46
6.	BREAKING-IN A NEW TRAILER	47
6.1.	RETIGHTEN LUG NUTS AT FIRST 10, 25 & 50 MILES	47
6.2.	ADJUST BRAKE SHOES AT FIRST 200 MILES.....	47

6.3.	SYNCHRONIZING THE BRAKE SYSTEMS.....	47
7.	ACCESSORIES	48
7.1.	GASOLINE-POWERED ELECTRIC GENERATORS	48
7.2.	ACCESSORY BATTERY	49
7.3.	SHORE POWER.....	49
7.4.	LP GAS FUEL SYSTEM.....	50
7.4.1.	<i>LP Gas System Troubleshooting</i>	51
7.5.	VENDING & ACCESSORY DOORS.....	52
7.6.	ELECTRIC-POWERED LANDING GEAR.....	52
7.7.	SPREAD AXLES.....	52
7.8.	REFUELING STATION	52
7.9.	TRAILER ROOF	53
8.	INSPECTION, SERVICE & MAINTENANCE.....	54
8.1.	INSPECTION, SERVICE & MAINTENANCE SUMMARY CHARTS	54
8.2.	INSPECTION AND SERVICE INSTRUCTIONS.....	56
8.2.1.	<i>Axle Bolts, Frame, Suspension, & Structure</i>	56
8.2.2.	<i>Trailer Structure</i>	56
8.2.2.1.	Fasteners and Frame Members	56
8.2.2.2.	Welds.....	56
8.2.3.	<i>Drop Ramp Torsion Springs</i>	57
8.2.4.	<i>Slide-Outs</i>	57
8.2.5.	<i>Trailer Brakes</i>	57
8.2.5.1.	Brake Shoes and Drums.....	57
8.2.5.2.	Manually Adjusting Brake Shoes	57
8.2.5.3.	Brakes, Electric.....	57
8.2.5.4.	Brakes, Hydraulic (vacuum, air or electric operated).....	58
8.2.6.	<i>Trailer Connection to Tow Vehicle</i>	59
8.2.6.1.	Coupler and Ball	59
8.2.6.2.	Gooseneck.....	59
8.2.6.3.	Fifth Wheel Kingpin.....	59
8.2.7.	<i>Landing Leg or Jack</i>	60
8.2.8.	<i>Lights and Signals</i>	60
8.2.9.	<i>Accessory Battery</i>	60
8.2.10.	<i>Tires</i>	60
8.2.11.	<i>Wheel Rims</i>	61
8.2.12.	<i>Wheels, Bearings and Lug Nuts</i>	61
8.2.12.1.	Lug Nuts (Bolts).....	61

1. GENERAL SAFETY INFORMATION

1.1. SAFETY ALERT SYMBOLS AND SIGNAL WORDS

An Owner's Manual that provides general trailer information cannot cover all of the specific details necessary for the proper combination of every trailer, tow vehicle and hitch. Therefore, you must read, understand and follow the instructions given by the tow vehicle and trailer hitch manufacturers, as well as the instructions in this manual.

Our trailers are built with components produced by various manufacturers. Some of these items have separate instruction manuals. Where this manual indicates that you should read another manual, and you do not have that manual, call Pace American at 877-475-5665 for a free copy.

The safety information in this manual is denoted by the safety alert symbol: 

The level of risk is indicated by the following signal words.

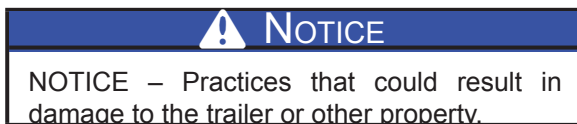
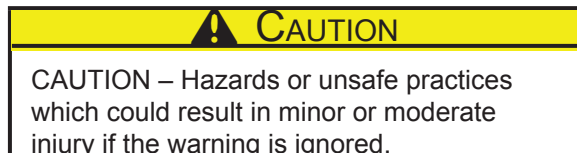
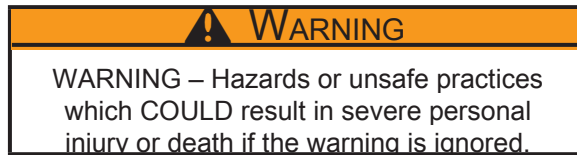

1.2. MAJOR HAZARDS

Loss of control of the trailer or trailer/tow vehicle combination can result in death or serious injury. The most common causes for loss of control of the trailer are:

- Improper sizing of the trailer for the tow vehicle, or vice versa.
- Excessive Speed: Driving too fast for the conditions.

- Failure to adjust driving behavior when towing a trailer.
- Overloading and/or improper weight distribution.
- Improper or mis-coupling of the trailer to the hitch.
- Improper braking and steering under sway conditions.
- Not maintaining proper tire pressure.
- Not maintaining proper torque on lugnuts.

1.2.1. **IMPROPER SIZING OF THE TRAILER TO THE TOW VEHICLE.**

Trailers that weigh too much for the towing vehicle can cause stability problems, which can lead to death or serious injury. Furthermore, the additional strain put on the engine and drive-train may lead to serious tow vehicle maintenance problems. For these reasons the maximum towing capacity of your towing vehicle should not be exceeded. The towing capacity of your tow vehicle, in terms of maximum Gross Trailer Weight (GTW) and maximum Gross Combined Weight Rating (GCWR) can be found in the tow vehicles Owner's Manual. Weight Distribution Bars are required by many Tow Vehicle Manufactures. When recommended you **MUST** use a Weight distribution system.

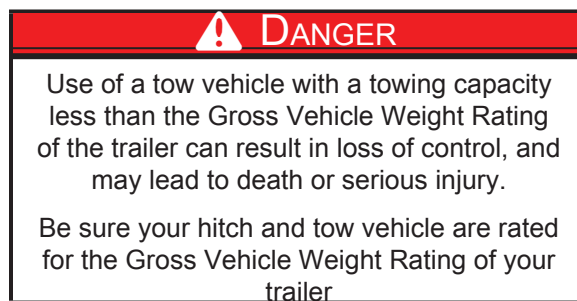

1.2.2. **DRIVING TOO FAST**

With ideal road conditions, the maximum recommended speed for safely towing a trailer varies from state to state. If you drive too fast, the trailer is more likely to sway, thus increasing the possibility for loss of control. Also your tires may overheat, thus increasing the possibility of a blowout.

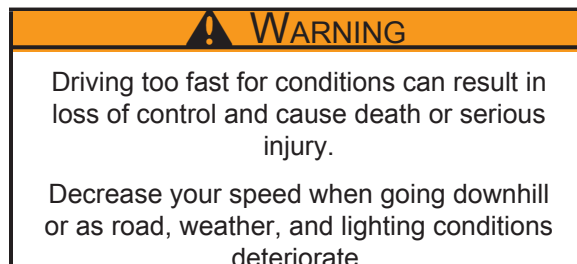

1.2.3. **FAILURE TO ADJUST DRIVING BEHAVIOR WHEN TOWING A TRAILER**

When towing a trailer, you will have decreased acceleration, increased stopping distance, and increased turning radius (which means you must make wider turns to keep from hitting curbs, vehicles, and anything else that is on the inside corner). Furthermore the trailer will change the handling characteristics of your towing vehicle, making it more sensitive to steering inputs and more likely to be pushed around in windy conditions or when being passed by large vehicles. In addition, you will need a longer distance to pass, due to slower acceleration and increased length. With these caveats in mind:

- Be alert for slippery conditions. You are more likely to be affected by slippery road surfaces when driving a tow vehicle with a trailer, than driving a tow vehicle without a trailer.
- Anticipate the trailer “swaying.” Swaying can be caused by excessive steering, wind gusts, roadway edges, or by the trailer reaction to the pressure wave created by passing trucks and busses.
- When encountering trailer sway take your foot off the gas, and steer as little as possible in order to stay on the road. Use small “trim-like” steering adjustments. Do not attempt to steer out of the sway; you’ll only make

it worse. Also do not apply the tow vehicle brakes to correct trailer swaying. On the other hand, application of the trailer brakes alone will tend to straighten out the combination, especially when going downhill.

- Check rearview mirrors frequently to observe the trailer and traffic.
- Use lower gear when driving down steep or long grades. Use the engine and transmission as a brake. Do not ride the brakes, as they can overheat and become ineffective.
- Be aware of your trailer height, especially when approaching bridges, roofed areas and around trees.

1.2.4. TRAILER NOT PROPERLY COUPLED TO THE HITCH

It is critical that the trailer be securely coupled to the hitch ball, and that the safety chains and emergency break-away brake cable are correctly attached. Uncoupling may result in death or serious injury to you and to others.

 **WARNING**

Proper selection and condition of the coupler and hitch are essential to safely towing your trailer. A loss of coupling may result in death or serious injury.

- Be sure the maximum load rating of the hitch on the tow vehicle is equal to or greater than the maximum load rating of the coupler on the trailer.
- Be sure the hitch ball size matches the coupler size.
- Observe the hitch for wear, corrosion and cracks before coupling. Replace worn, corroded or cracked hitch components before coupling the trailer to the tow vehicle.
- Be sure the hitch components are tight before coupling the trailer to the tow vehicle.
- A loose hitch-ball nut can result in uncoupling, leading to death or serious injury.
- Be sure the hitch ball is tight to the hitch before coupling the trailer.

 **WARNING**

An improperly coupled trailer can result in death or serious injury.

Do not move the trailer until:

- The coupler is secured and locked to hitch ball;
- The safety chains are secured to the tow vehicle; and
 - The trailer jack(s) are fully retracted.

Do not tow the trailer on the road until:

- Tires and wheels are checked;
- The trailer brakes are checked;
- The breakaway switch is connected to the tow vehicle;
 - The load is secured to the trailer; and
 - The trailer lights are connected and checked.

1.2.5. PROPER USE OF SAFETY CHAINS

If your trailer comes loose from the hitch for any reason, we have provided safety chains so that control of the trailer can still be maintained

! WARNING

Improper rigging of the safety chains can result in loss of control of the trailer and tow vehicle, leading to death or serious injury, if the trailer uncouples from the tow vehicle.

- Fasten chains to frame of tow vehicle. Do not fasten chains to any part of the hitch unless the hitch has holes or loops specifically for that purpose.
- Cross chains underneath hitch and coupler with enough slack to permit turning and to hold tongue up, if the trailer comes loose
- The safety chains spring loaded safety latches must be fully engaged once attached to the tow vehicle.

1.2.6. PROPER CONNECTION OF BREAKAWAY BRAKE

If equipped with brakes your trailer will be equipped with a breakaway brake system that can apply the brakes on your trailer if your trailer comes loose from the hitch ball for any reason. You will have a separate set of instructions for the breakaway brake if your trailer is so equipped. The breakaway brake system, including battery, must be in good condition and properly rigged to be effective.

! WARNING

An ineffective or inoperative breakaway brake system can result in a runaway trailer, leading to death or serious injury, if the coupler or hitch fails.

The breakaway cable must be connected to the tow vehicle; and NOT to any part of the hitch.

Before towing the trailer, test the function of the breakaway brake system. If the breakaway brake system is not working, do not tow the trailer; have it serviced or repaired.

1.2.7. MATCHING TRAILER AND HITCH

! Danger

Use of a hitch with a load rating less than the load rating of the trailer can result in loss of control and may lead to death or serious injury.

1.2.8. WORN TIRES, LOOSE WHEELS AND LUG NUTS

Just as with your tow vehicle the trailer tires and wheels are important safety items. Therefore, it is essential to inspect the trailer tires before each tow.

If a tire has a bald spot, bulge, cut, cracks, or is showing any cords, replace the tire before towing. If a tire has uneven tread wear, take the trailer to a dealer service center for diagnosis. Uneven tread wear can be caused by tire imbalance, axle misalignment or incorrect inflation.

Tires with too little tread will not provide adequate frictional forces on wet roadways and can result in loss of control, leading to death or serious injury.

Improper tire pressure causes increased tire wear and may reduce trailer stability, which can result in a tire blowout or possible loss of control. Therefore, before each tow you must also check the tire pressure.

Remember, the proper tire pressure is listed on the Certification / VIN label, normally mounted on front left side of the trailer, and should be checked when tires are cold. Allow 3 hours cool-down after driving as much as 1 mile at 40 mph before checking tire pressure.

 WARNING
Improper tire pressure can result in a blowout and loss of control, which can lead to death or serious injury.
Be sure tires are inflated to pressure indicated on the Certification / VIN label before towing trailer.

Proper Torque of the lug nuts is very important in keeping the wheels properly seated to the hub. Before each tow, check to make sure they torqued to the specified rating.

 WARNING
Metal creep between the wheel rim and hub may cause lug nuts to loosen and could result in a wheel coming off, leading to death or serious injury.
Tighten lug nuts before each tow.

The proper tightness (torque) for lug nuts is listed in Section 8.2.12.1 in the “Inspection and Service Instructions” chapter of this manual. Use a torque wrench to tighten the lug nuts, use the crisscross star pattern on page 68.

Lug nuts are also prone to loosen after first being assembled. When driving a new trailer (or after wheels have been remounted), check to make sure they are tight after the first 10, 25 and 50 miles of driving and before each tow thereafter.

Failure to perform this check can result in a wheel separating from the trailer and a crash, leading to death or serious injury.

Certain aluminum rims require the use of a thin walled socket. Owners should verify their wrench/socket combination works for their trailer upon purchase.

 WARNING
Lug nuts are prone to loosen after initial installation, which can lead to death or serious injury.
Check lug nuts for tightness on a new trailer or when wheel(s) have been remounted after the first 10, 25 and 50 miles of driving.

 WARNING
Improper lug nut torque can cause a wheel separating from the trailer, leading to death or serious injury.
Be sure lug nuts are tight before each tow.

1.2.9. **IMPROPER LOADING**

The total weight of the load you put in or on the trailer, plus the empty weight of the trailer itself, must not exceed the trailer’s Gross Vehicle Weight Rating (GVWR). If you do not know the empty weight of the trailer plus the cargo weight, you must weigh the loaded trailer at a commercial scale. In addition, you must distribute the load in the trailer such that the load on any axle does not exceed the Gross Axle Weight Rating (GAWR). If your

trailer is equipped with a Tire & Loading Information Placard, mounted next to the Certification / VIN label, the cargo capacity weight stated on that placard is only a close estimate. The GVWR and GAWR's are listed on the Certification / VIN label mounted on the front left side of the trailer.

 WARNING
<p>An overloaded trailer can result in loss of control of the trailer, leading to death or serious injury.</p> <p>Do not exceed the trailer Gross Vehicle Weight Rating (GVWR) or an axle Gross Axle Weight Rating (GAWR).</p> <p>Do not load a trailer so that the weight on any tire exceeds its rating.</p>

1.2.10. UNSAFE LOAD DISTRIBUTION

Improper front / rear load distribution can lead to poor trailer sway stability or poor tow vehicle handling. Poor trailer sway stability results from tongue weights that are too low, and poor tow vehicle stability results from tongue weights that are too high. Refer to Chapter heading "Loading the Trailer" for more information.

In the table below, the second column shows the rule of thumb percentage of total weight of the trailer plus its cargo (Gross Trailer Weight, or "GTW") that should appear on the tongue of the trailer. For example, a trailer with a gooseneck hitch, with a loaded weight of 12,000 pounds, should have 20-25% of 12,000 pounds (2400-3000 lbs.) on the gooseneck. For non-flowable (discrete) loads locate the load such as to provide the proper tongue weight.

After loading, be sure to check that none of the axles are overloaded.

Tongue Weight as a Percentage of Loaded Trailer Weight	
Type of Hitch	Percentage
Ball Hitch (or Bumper Hitch)	10–15% for large trailers
	6-10% for smaller utility and cargo trailers
	5-7% for boat trailers
Gooseneck Hitch	20–25%
Fifth Wheel Hitch	

The numbers quoted above are for example purposes and should be tailored to the specific trailer. For questions regarding the actual percent of tongue weight for your trailer, check your model specific Literature or call 877-475-5665.

Uneven left / right load distribution can cause tire, wheel, axle or structural failure. Be sure your trailer is evenly loaded left / right. Towing stability also depends on keeping the center of gravity as low as possible.

 WARNING
<p>Improper tongue weight (load distribution) can result in loss of control of the trailer, leading to death or serious injury.</p> <p>Make certain that tongue weight is within the allowable range.</p> <p>Be sure to:</p> <ul style="list-style-type: none"> • Distribute the load front-to-rear to provide proper tongue weight (see chart). <ul style="list-style-type: none"> • Distribute the load evenly, right and left. • Keep the center of gravity low.

1.2.11. SHIFTING CARGO

Since the trailer “ride” can be bumpy and rough, you must secure your cargo so that it does not shift while the trailer is being towed.

 WARNING
Shifting cargo can result in loss of control of the trailer, and can lead to death or serious injury.
Tie down all loads with proper sized fasteners, ropes, straps, etc.

If the door latch is equipped with a catch that has a hole for a linchpin, use a linchpin to prevent the door latch from opening.

 WARNING
Engage deadbolt lock when towing trailer to prevent accidental door opening while in transit.

 WARNING
If the door opens, your cargo may be ejected onto the road, resulting in death or serious injury to other drivers.
Always secure the door latch after closing. Place a linchpin in the catch.

1.2.12. INAPPROPRIATE CARGO

Your trailer may be designed for specific cargo, for example, only for vehicles. If your trailer is designed for specific cargo, only carry that cargo in the trailer. A utility trailer must not be used to carry certain items, such as people, containers of hazardous substances or containers of flammable substances.

 WARNING
Do not transport people inside the trailer, even if it has living quarters. The transport of people puts their lives at risk and may be illegal.

! WARNING

Do not transport flammable, explosive, poisonous or other dangerous materials in your trailer.

See your dealer for proper ventilation requirements or consult the manufacturer for ventilation guidelines.

Exceptions:

- Fuel in the tanks of vehicles that are being towed
- Fuel stored in proper containers used in trailer living quarters for cooking
- Fuel stored in the tank of an on-board generator

1.2.13. INOPERABLE BRAKES, LIGHTS OR MIRRORS

Be sure that the electric brakes and all of the lights on your trailer are functioning properly before towing your trailer. Electric brakes and lights on a trailer are controlled via a connection to the tow vehicle, generally a multi-pin electrical connector. Check the trailer tail lights by turning on your tow vehicle headlights. Check the trailer brake lights by having someone step on the tow vehicle brake pedal while you look at trailer lights. Do the same thing to check the turn signal lights.

If your trailer has electric brakes, your tow vehicle will have an electric brake controller that sends power to the trailer brakes. Before towing the trailer on the road, you must operate the brake controller while trying to pull the trailer in order to confirm that the electric brakes operate. While towing the trailer at less than 5 mph, manually operate the electric brake controller in the tow vehicle cab. You should feel the operation of the trailer brakes.

! WARNING

Improper electrical connection between the tow vehicle and the trailer will result in inoperable lights and electric brakes, and can lead to collision.

Before each tow:

- Check that the taillights, brake lights and turn signals work
- Check that the electric brakes work by operating the brake controller inside the tow vehicle

If your trailer has hydraulic “surge” brakes, pull the emergency break-away brake lanyard to check the operation of the surge mechanism.

Standard mirrors usually do not provide adequate visibility for viewing traffic to the sides and rear a towed trailer. You must provide mirrors that allow you to safely observe approaching traffic.

1.2.14. HAZARDS FROM MODIFYING YOUR TRAILER

Essential safety items can be damaged by altering your trailer. Even simply driving a nail or screw to hang something can damage an electrical circuit, LP gas line or other feature of the trailer.

Before making any alteration to your trailer, contact your dealer or Pace American at 877-475-5665 and describe the alteration you are contemplating. Alteration of the trailer structure or modification of mechanical, electrical, plumbing, heating or other systems on your trailer must be performed only by qualified technicians who are familiar with the system as installed on your trailer.

1.2.15. HAZARDS FROM ACCESSORIES

The “Accessories” chapter of this manual contains some information about certain optional accessories that may be on your trailer. Read and follow all of these instructions before operating the accessories. The major hazards from some of these accessories are:

1.2.15.1. Generator

If your trailer is equipped with a gasoline or diesel generator, you must have and follow the generator manufacturer’s instructions. You must also have one or more carbon monoxide detectors in the trailer’s accommodation spaces.

Carbon Monoxide is an odorless gas that can cause death. Be certain exhaust from a running generator does not accumulate in or around your trailer, by situations such as:

- Being drawn in by fans or ventilators operated in a trailer;
- Prevailing wind;
- Being trapped between your trailer and other trailers, vehicles or buildings; or
- Being trapped between your trailer and, or in a snow bank, or other nearby objects

 **WARNING**

Operating gasoline and diesel generators can lead to death or serious injury by:

- Carbon Monoxide
- Fire and Explosion
- Electrocution

Have a working carbon monoxide detector in the accommodation spaces before operating a generator.

Do not refuel a running generator or refuel near ignition sources.

1.2.15.2. Shore Power

“Shore Power” is the name given to connecting your trailer to a source of electrical power using an extension cord specifically designed for that purpose.

 **WARNING**

Shore power poses a risk of death due to electrocution or fire

- Always use an electrical cord specifically designed for shore power connection. Never use an ordinary extension cord.
- Always connect the electrical cord to a grounded source of shore power.
 - Do not remove the “third prong” from the shore power plug.
 - Connect only to source of proper voltage.
 - Make certain polarity is correct.
 - Do not overload electrical circuits.
- Always replace fuses or circuit breakers with correct rating.

See the “Accessories” chapter section 7.3 for more detailed information.

1.2.15.3. LP Gas Fuel System

See the “Accessories” chapter section 7.4 for more detailed information.

 DANGER
<p>You can die or be brain damaged by Carbon Monoxide.</p> <p>Make certain the exhaust from LP appliances is directed to the outdoors.</p> <p>Have a working carbon monoxide detector in the accommodation spaces of your trailer before operating any LP gas appliance.</p> <p>Do not operate portable grills or stoves inside the trailer.</p>

 WARNING
<p>Risk of death due to fire or explosion.</p> <p>Only connect an LP gas system to a supply of LP gas, NOT natural gas.</p> <p>Do not store LP gas tanks inside the trailer.</p> <p>Only fill an LP gas tank 80% full.</p> <p>Only fill the tank with LP gas (butane or propane).</p> <p>Overfilled tanks can release gas and cause an explosion.</p>

 WARNING
<p>Risk of fire or explosion</p> <p>If LP gas is detected (by smell or by the LP gas detector):</p> <ul style="list-style-type: none">• Do not touch electrical switches• Extinguish flames and pilot lights<ul style="list-style-type: none">• Open doors for ventilation• Shut off LP gas supply at the LP tank• Leave the area until odor clears <p>Correct the source of LP gas leakage before using LP appliances.</p> <p>Do not use a flame to locate the source of an LP gas leak.</p>

 WARNING
<p>Risk of fire or explosion</p> <p>Never use a flame, heat lamp or hair dryer to thaw an LP gas regulator. Use an incandescent light bulb.</p> <p>Do not remove the regulator cover or attempt to service the LP gas regulator.</p>

1.2.15.4 Fenders

Fenders and Fender Flares are not structural trailer components. Therefore they should not be used as steps or benches in any circumstance.

1.2.15.5 **Refueling Station**

! WARNING

If your trailer is equipped with a refueling station, smoking is prohibited and a grounding wire is required.

Failure to do so can result in injury or death.

1.2.15.6 **Trailer Roof**



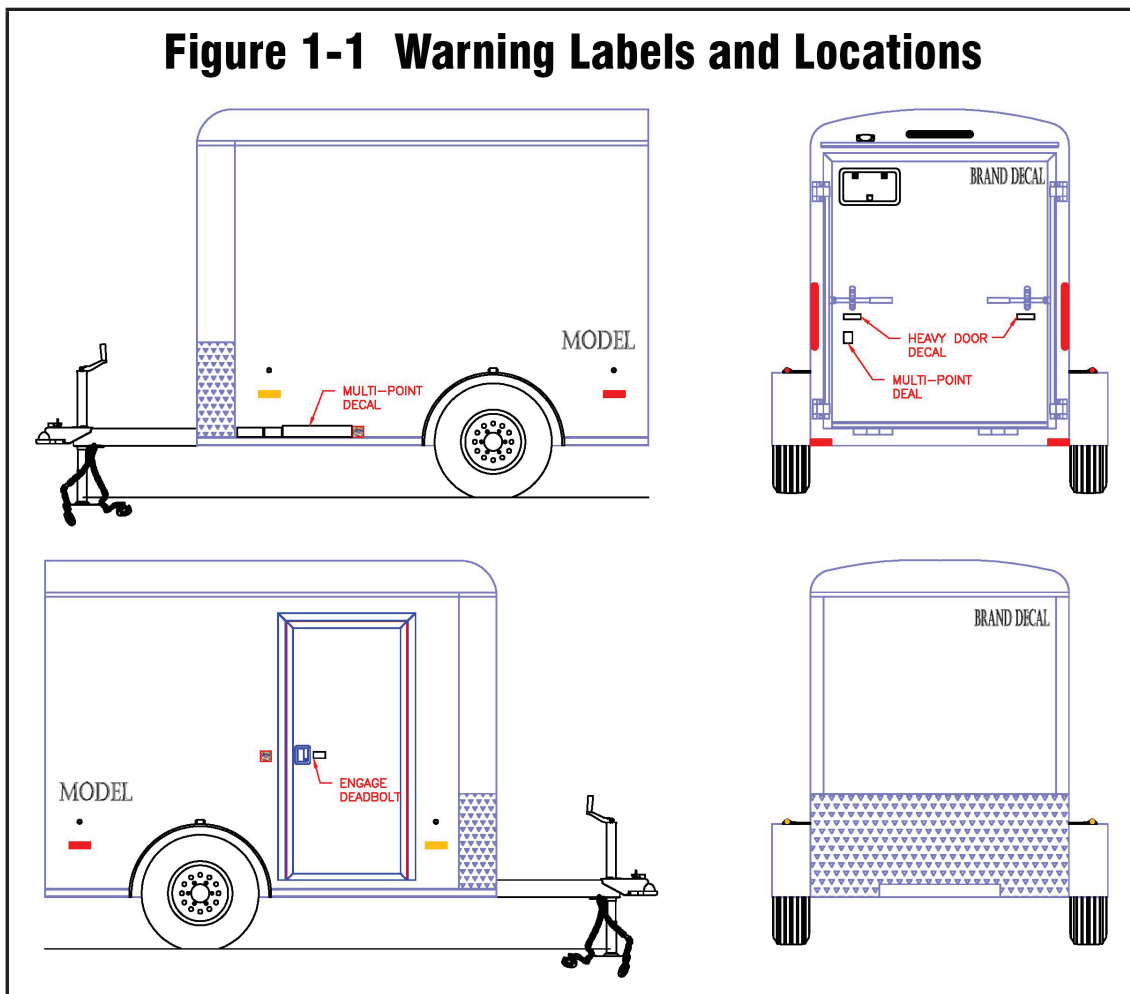

! WARNING

Never climb on the roof of your trailer. Unless your trailer is specifically designed for this purpose, serious injury or death could occur.

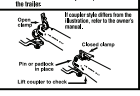
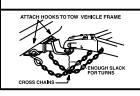
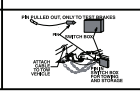
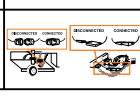
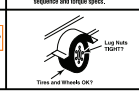
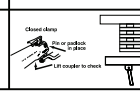
1.2.16. **SAFETY WARNING LABELS ON YOUR TRAILER**

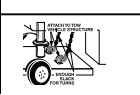

<p>⚠ WARNING</p> <ul style="list-style-type: none"> Do not operate this trailer unless you have read and understand the safety information in the owner's manual! Failure to properly operate and maintain the towing vehicle and trailer can result in injury. 	<p>⚠ WARNING</p> <p>Overloading will cause trailer to come loose from tow vehicle. You must:</p> <ol style="list-style-type: none"> CHECK that the LOAD RATING is same as or greater than coupler LOAD RATING. CHECK that the SIZE is same as coupler. CLOSE COUPLER CLAMP on ball. LIFT tongue assembly to test that it will not separate from ball. LOCK coupler clamp with pin or padlock. LOCK check each time you stop and leave the trailer. 	<p>⚠ WARNING</p> <p>ALWAYS use safety chains. Chains hold trailer if connection fails. You must:</p> <ol style="list-style-type: none"> CROSS chains underneath coupler. ALLOW slack for trailer to turn. ATTACH chain hooks securely to tow vehicle frame. 	<p>⚠ WARNING</p> <p>Trailer can roll if it comes loose. Electric safety brake applies when CHASER pin out of switch box.</p> <ol style="list-style-type: none"> PULL handle to get pin out of switch box. CHECK brake by PULLING TRAILER with tow vehicle. ATTACH pin CABLE to tow vehicle or pin will be pulled out if trailer separates. Properly REPLACE pin in switch box. 	<p>⚠ WARNING</p> <p>Lights can prevent trailer from being hit by other vehicles. You must:</p> <ol style="list-style-type: none"> CONNECT trailer and tow vehicle electrical connectors. CHECK all lights: tail lights, turn signal, and brake lights. DO NOT TOW if lights are not working. 	<p>⚠ WARNING</p> <p>The wheel or leg nut failure can cause loss of control. Before towing, you must CHECK:</p> <ol style="list-style-type: none"> The pressure and tread. Tires and wheels for damage. Log nuts for tightness. <p>For new and remounted wheels, re-tighten log nuts at the first 10, 25 and 50 miles of driving.</p> <ol style="list-style-type: none"> Refer to owner's manual for tightening sequence and torque specs. 	<p>⚠ WARNING</p> <p>Trailer must be coupled to tow vehicle before loading trailer.</p> <p>Lower rear stand(s) if equipped, or chock blocking under the rear of the trailer to prevent injury or damage when loading.</p> <p>Make sure all jacks are raised to their highest positions before towing.</p> 	<p>⚠ WARNING</p> <ul style="list-style-type: none"> Carbon monoxide or other harmful vapors can enter through the floor openings. Carbon monoxide can cause death or serious injury. This trailer is not intended to sleep in. If you enter this trailer for sleeping purposes you must equip it with a carbon monoxide detector. <p>Refer to the owner's manual for a full list of precautions.</p>	<p>⚠ WARNING</p> <ul style="list-style-type: none"> Do not exceed manufacturer's weight ratings or recommendations. You must weigh your loaded trailer to be sure you haven't exceeded the trailer's GVWR. If you experience trailer sway: <ol style="list-style-type: none"> Slow down Go to safe place Check tongue position Reposition heavier cargo towards the front
--	---	---	--	---	---	--	--	--

<p>⚠ WARNING</p> <ul style="list-style-type: none"> Do not operate this trailer unless you have read and understand the safety information in the owner's manual! Failure to properly operate and maintain the towing vehicle and trailer can result in injury. 	<p>⚠ WARNING</p> <p>Overloading will cause trailer to come loose from tow vehicle. You must:</p> <ol style="list-style-type: none"> CHECK that the LOAD RATING is same as or greater than coupler LOAD RATING. CHECK that the SIZE is same as coupler. CLOSE COUPLER CLAMP on ball. LIFT tongue assembly to test that it will not separate from ball. LOCK coupler clamp with pin or padlock. LOCK check each time you stop and leave the trailer. 	<p>⚠ WARNING</p> <p>ALWAYS use safety chains. Chains hold trailer if connection fails. You must:</p> <ol style="list-style-type: none"> CROSS chains underneath coupler. ALLOW slack for trailer to turn. ATTACH chain hooks securely to tow vehicle frame. 	<p>⚠ WARNING</p> <p>Trailer can roll if it comes loose. Electric safety brake applies when CHASER pin out of switch box.</p> <ol style="list-style-type: none"> PULL handle to get pin out of switch box. CHECK brake by PULLING TRAILER with tow vehicle. ATTACH pin CABLE to tow vehicle or pin will be pulled out if trailer separates. Properly REPLACE pin in switch box. 	<p>⚠ WARNING</p> <p>Lights can prevent trailer from being hit by other vehicles. You must:</p> <ol style="list-style-type: none"> CONNECT trailer and tow vehicle electrical connectors. CHECK all lights: tail lights, turn signal, and brake lights. DO NOT TOW if lights are not working. 	<p>⚠ WARNING</p> <p>The wheel or leg nut failure can cause loss of control. Before towing, you must CHECK:</p> <ol style="list-style-type: none"> The pressure and tread. Tires and wheels for damage. Log nuts for tightness. <p>For new and remounted wheels, re-tighten log nuts at the first 10, 25 and 50 miles of driving.</p> <ol style="list-style-type: none"> Refer to owner's manual for tightening sequence and torque specs. 	<p>⚠ WARNING</p> <p>Trailer must be coupled to tow vehicle before loading trailer.</p> <p>Lower rear stand(s) if equipped, or chock blocking under the rear of the trailer to prevent injury or damage when loading.</p> <p>Make sure all jacks are raised to their highest positions before towing.</p> 	<p>⚠ WARNING</p> <ul style="list-style-type: none"> Carbon monoxide or other harmful vapors can enter through the floor openings. Carbon monoxide can cause death or serious injury. This trailer is not intended to sleep in. If you enter this trailer for sleeping purposes you must equip it with a carbon monoxide detector. <p>Refer to the owner's manual for a full list of precautions.</p>
--	---	---	--	---	---	--	--

⚠ DANGER

Heavy Door Stand Clear

Failure to comply can result in serious injury.

HA-2067

⚠ CAUTION

ENGAGE DEADBOLT LOCK WHEN TOWING TRAILER TO PREVENT ACCIDENTAL DOOR OPENING WHILE IN TRANSIT.

⚠ **WARNING**

To protect you and others against death or serious injury, all of the labels shown above must be on the trailer and must be legible.

If any of these labels are missing or cannot be read, call Pace American at 877-475-5665 for free replacement labels.

You will need to provide us with the number shown at the bottom of the label(s) in order for us to send the correct one(s).

1.2.17. TRAILER TOWING GUIDE

Driving a vehicle with a trailer in tow is vastly different from driving the same vehicle without a trailer in tow. Acceleration, maneuverability and braking are all diminished with a trailer in tow. It takes longer to get up to speed; you need more room to turn and pass, and more distance to stop when towing a trailer. You will need to spend time adjusting to the different feel and maneuverability of the tow vehicle with a loaded trailer. Because of the significant differences in all aspects of maneuverability when towing a trailer, the hazards and risks of injury are also much greater than when driving without a trailer. You are responsible for keeping your vehicle and trailer in control, and for all the damage that is caused if you lose control of your vehicle and trailer.

As you did when learning to drive an automobile, find an open area with little or no traffic for your first practice trailering. Of course, before you start towing the trailer, you must follow all of the instructions for inspection, testing, loading and coupling. Also, before you start towing, adjust the mirrors so you can see the trailer as well as the area to the rear of it.

Drive slowly at first, 5 mph or so, and turn the wheel to get the feel of how the tow vehicle and trailer combination responds. Next, make some right and left hand turns. Watch in your side mirrors to see how the trailer follows the tow vehicle. Turning with a trailer attached requires more room.

Stop the rig a few times from speeds no greater than 10 mph. If your trailer is equipped with brakes, try using different combinations of trailer/electric brake and tow vehicle brake. Note the effect that the trailer brakes have when they are the only brakes used. When properly adjusted, the trailer brakes will come on just before the tow vehicle brakes.

It will take practice to learn how to back up a tow vehicle with a trailer attached. Take it slow. Before backing up, get out of the tow vehicle and look behind the trailer to make sure that there are no obstacles. Some drivers place their hands at the bottom of the steering wheel, and while the tow vehicle is in reverse, “think” of the hands as being on the top of the wheel. When the hands move to the right (counter-clockwise, as you would do to turn the tow vehicle to the left when moving forward), the rear of the trailer moves to the right. Conversely, rotating the steering wheel clockwise with your hands at the bottom of the wheel will move the rear of the trailer to the left, while backing up. If you are towing a bumper hitch rig, be careful not to allow the trailer to turn too much, because it will hit the rear of the tow vehicle. To straighten the rig, either pull forward, or turn the steering wheel in the opposite direction.

1.2.18. REPORTING SAFETY DEFECTS

If you believe that your vehicle has a defect that could cause a crash or could cause injury or death, you should immediately inform the National Highway Traffic Safety Administration (NHTSA) in addition to notifying Pace American.

If NHTSA receives similar complaints, it may open an investigation, and if it finds that a safety defect exists in a group of vehicles, it may order a recall and remedy campaign. However, NHTSA cannot become involved in individual problems between you, your dealer, or Pace American.

To contact NHTSA, you may either call the Vehicle Safety Hotline toll-free at 1-888-327-4236 (TTY: 1-800-424-9153), go to <http://www.nhtsa.gov>; or write to: Administrator, NHTSA, 1200 New Jersey Ave. SE., Washington, DC 20590. You can also obtain other information about motor vehicle safety from <http://www.nhtsa.gov>.

Call 877-475-5665 to reach Pace American.

1.2.19. WARRANTY CLAIMS

For warranty coverage, you must immediately contact the dealer from which your unit was purchased to make a warranty claim. The dealer that sold you the trailer will initiate the claims process in order to obtain approval for warranty work.

1.3. SAFE TRAILER TOWING GUIDELINES

- Recheck the load tiedowns to make sure the load will not shift during towing.
- Before towing, check coupling, safety chain, safety brake, tires, wheels and lights.
- Check the lug nuts or bolts for tightness.
- Check coupler tightness after towing 50 miles.
- Adjust the brake controller to engage the trailer brakes before the tow vehicle brakes. Follow the instructions given with the brake controller manufacturer’s literature.
- Use your mirrors to verify that you have room to change lanes or pull into traffic.
- Use your turn signals well in advance.
- Allow plenty of stopping space for your trailer and tow vehicle.
- Do not drive so fast that the trailer begins to sway due to speed. Generally never drive faster than 60 m.p.h.
- Allow plenty of room for passing. A rule of thumb is that the passing distance with a trailer is 4 times the passing distance without a trailer.
- Shift your automatic transmission into a lower gear for city driving.
- Use lower gears for climbing and descending grades.
- Do not ride the brakes while descending grades, they may get so hot that they stop working. Then you will potentially have a runaway tow vehicle and trailer.
- To conserve fuel, don’t use full throttle to climb a hill. Instead, build speed on the approach.
- Slow down for bumps in the road. Take your foot off the brake when crossing the bump.
- Do not brake while in a curve unless absolutely necessary. Instead, slow down before you enter the

curve.

- Do not apply the tow vehicle brakes to correct extreme trailer swaying. Instead, lightly apply the trailer brakes with the hand controller.
- Make regular stops, about once each hour. Confirm that
 - The coupler is secure to the hitch and is locked,
 - Electrical connectors are made,
 - There is appropriate slack in the safety chains,
 - There is appropriate slack in the breakaway switch pullpin cable,
 - The tires are not visibly low on pressure, and
 - The cargo is secure and in good condition.

2. TIRE SAFETY INFORMATION

This portion of the User's Manual contains tire safety information as required by 49 CFR 575.6.

Section 2.1 contains "Steps for Determining Correct Load Limit - Trailer".

Section 2.2 contains "Steps for Determining Correct Load Limit – Tow Vehicle".

Section 2.3 contains information from the NHTSA brochure entitled "Tire Safety – Everything Rides On It".

This brochure describes the following items;

- Tire labeling, including a description and explanation of each marking on the tires, and information about the DOT Tire Identification Number (TIN).
- Recommended tire inflation pressure, including a description and explanation of:
 - A. Cold inflation pressure.
 - B. Vehicle Placard and location on the vehicle.
 - C. Adverse safety consequences of under inflation (including tire failure).
 - D. Measuring and adjusting air pressure for proper inflation.
- Tire Care, including maintenance and safety practices.
- Vehicle load limits, including a description and explanation of the following items:
 - A. Locating and understanding the load limit information, total load capacity, and cargo capacity.
 - B. Calculating total and cargo capacities with varying seating configurations including quantitative examples showing / illustrating how the vehicles cargo and luggage capacity decreases as combined number and size of occupants' increases. This item is also discussed in Section 3.
 - C. Determining compatibility of tire and vehicle load capabilities.
 - D. Adverse safety consequences of overloading on handling and stopping on tires.

2.1. STEPS FOR DETERMINING CORRECT LOAD LIMIT – TRAILER

2.1.1. TRAILERS 10,000 POUNDS GVWR OR LESS

1. Locate the statement, "The weight of cargo should never exceed XXX kg or XXX lbs.," on your vehicle's placard. See figure 1-1.
2. This figure equals the available amount of cargo and luggage load capacity.

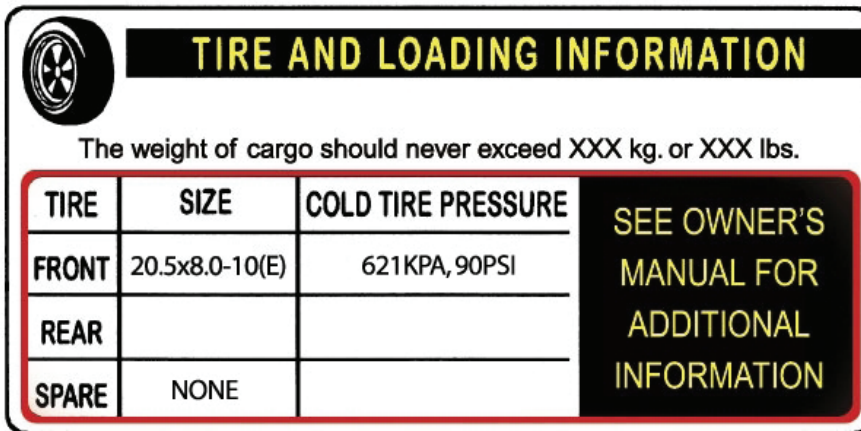

The image shows a rectangular placard with a black background and yellow text. At the top left is a tire icon. The title "TIRE AND LOADING INFORMATION" is in large yellow letters. Below the title, it says "The weight of cargo should never exceed XXX kg. or XXX lbs." in white. A table with three columns (TIRE, SIZE, COLD TIRE PRESSURE) and three rows (FRONT, REAR, SPARE) is shown. The table has a white border and is set against a black background. To the right of the table, it says "SEE OWNER'S MANUAL FOR ADDITIONAL INFORMATION" in yellow.

TIRE	SIZE	COLD TIRE PRESSURE
FRONT	20.5x8.0-10(E)	621KPA, 90PSI
REAR		
SPARE	NONE	

Tire and Loading Information Placard – Figure 1-1

3. Determine the combined weight of luggage and cargo being loaded on the vehicle. That weight may not safely exceed the available cargo and luggage load capacity.

The trailer's placard refers to the Tire Information Placard attached adjacent to or near the trailer's VIN (Certification) label at the left front of the trailer.

Note: The following calculations in Sections 2.1.2 and 2.2 are not required by the government. For the purpose of completeness, NATM has included these statements.

2.1.2. TRAILERS OVER 10,000 POUNDS GVWR (NOTE: THESE TRAILERS ARE NOT REQUIRED TO HAVE A TIRE INFORMATION PLACARD ON THE VEHICLE)

1. Determine the empty weight of your trailer by weighing the trailer using a public scale or other means. This step does not have to be repeated.
2. Locate the GVWR (Gross Vehicle Weight Rating) of the trailer on your trailer's VIN (Certification) label.
3. Subtract the empty weight of your trailer from the GVWR stated on the VIN label. That weight is the maximum available cargo capacity of the trailer and may not be safely exceeded.

2.2. STEPS FOR DETERMINING CORRECT LOAD LIMIT – TOW VEHICLE

1. Locate the statement, "The combined weight of occupants and cargo should never exceed XXX lbs.," on your vehicle's placard.
2. Determine the combined weight of the driver and passengers who will be riding in your vehicle.
3. Subtract the combined weight of the driver and passengers from XXX kilograms or XXX pounds.
4. The resulting figure equals the available amount of cargo and luggage capacity. For example, if the "XXX" amount equals 1400 lbs. and there will be five 150 lb. passengers in your vehicle, the amount of available cargo and luggage capacity is 650 lbs. (1400-750 (5 x 150) = 650 lbs.).
5. Determine the combined weight of luggage and cargo being loaded on the vehicle. That weight may not safely exceed the available cargo and luggage capacity calculated in Step # 4.
6. If your vehicle will be towing a trailer, load from your trailer will be transferred to your vehicle. Consult the tow vehicle's manual to determine how this weight transfer reduces the available cargo and luggage capacity of your vehicle.

2.3. TIRE SAFETY - EVERYTHING RIDES ON IT

The National Traffic Safety Administration (NHTSA) has published a brochure (DOT HS 809 361) that discusses all aspects of Tire Safety, as required by CFR 575.6. This brochure is reproduced in part below. It can be obtained and downloaded from NHTSA, free of charge, from the following web site:

http://www.nhtsa.dot.gov/cars/rules/TireSafety/ridesonit/tires_index.html

Studies of tire safety show that maintaining proper tire pressure, observing tire and vehicle load limits (not carrying more weight in your vehicle than your tires or vehicle can safely handle), avoiding road hazards, and inspecting tires for cuts, slashes, and other irregularities are the most important things you can do to avoid tire failure, such as tread separation or blowout and flat tires. These actions, along with other care and maintenance activities, can also:

- Improve vehicle handling
- Help protect you and others from avoidable breakdowns and accidents
- Improve fuel economy
- Increase the life of your tires.

This booklet presents a comprehensive overview of tire safety, including information on the following topics:

- Basic tire maintenance
- Uniform Tire Quality Grading System
- Fundamental characteristics of tires
- Tire safety tips.

Use this information to make tire safety a regular part of your vehicle maintenance routine. Recognize that the time you spend is minimal compared with the inconvenience and safety consequences of a flat tire or other tire failure.

2.3.1. SAFETY FIRST—BASIC TIRE MAINTENANCE

Properly maintained tires improve the steering, stopping, traction, and load-carrying capability of your vehicle. Underinflated tires and overloaded vehicles are a major cause of tire failure. Therefore, as mentioned above, to avoid flat tires and other types of tire failure, you should maintain proper tire pressure, observe tire and vehicle load limits, avoid road hazards, and regularly inspect your tires.

2.3.2. FINDING YOUR VEHICLE'S RECOMMENDED TIRE PRESSURE AND LOAD LIMITS

Tire information placards and vehicle certification labels contain information on tires and load limits. These labels indicate the vehicle manufacturer's information including:

- Recommended tire size
- Recommended tire inflation pressure
- Vehicle capacity weight (VCW—the maximum occupant and cargo weight a vehicle is designed to carry)
- Front and rear gross axle weight ratings (GAWR—the maximum weight the axle systems are designed to carry).

Both placards and certification labels are permanently attached to the trailer near the left front.

2.3.3. UNDERSTANDING TIRE PRESSURE AND LOAD LIMITS

Tire inflation pressure is the level of air in the tire that provides it with load-carrying capacity and affects the overall performance of the vehicle. The tire inflation pressure is a number that indicates the amount of air pressure—measured in pounds per square inch (psi)—a tire requires to be properly inflated. (You will also find this number on the vehicle information placard expressed in kilopascals (kPa), which is the metric measure used internationally.) Manufacturers of passenger vehicles and light trucks determine this number based on the vehicle's design load limit, that is, the greatest amount of weight a vehicle can safely carry and the vehicle's tire size. The proper tire pressure for your vehicle is referred to as the "recommended cold inflation pressure." (As you will read below, it is difficult to obtain the recommended tire pressure if your tires are not cold.)

Because tires are designed to be used on more than one type of vehicle, tire manufacturers list the "maximum permissible inflation pressure" on the tire sidewall. This number is the greatest amount of air pressure that should ever be put in the tire under normal driving conditions.

2.3.4. CHECKING TIRE PRESSURE

It is important to check your vehicle's tire pressure at least once a month for the following reasons:

- Most tires may naturally lose air over time.
- Tires can lose air suddenly if you drive over a pothole or other object or if you strike the curb when parking.
- With radial tires, it is usually not possible to determine underinflation by visual inspection.

For convenience, purchase a tire pressure gauge to keep in your vehicle. Gauges can be purchased at tire dealerships, auto supply stores, and other retail outlets.

The recommended tire inflation pressure that vehicle manufacturers provide reflects the proper psi when a tire is cold. The term cold does not relate to the outside temperature. Rather, a cold tire is one that has not been driven on for at least three hours. When you drive, your tires get warmer, causing the air pressure within them to increase. Therefore, to get an accurate tire pressure reading, you must measure tire pressure when the tires are cold or compensate for the extra pressure in warm tires.

2.3.5. STEPS FOR MAINTAINING PROPER TIRE PRESSURE

- Step 1: Locate the recommended tire pressure on the vehicle's tire information placard, certification label, or in the owner's manual.
- Step 2: Record the tire pressure of all tires.
- Step 3: If the tire pressure is too high in any of the tires, slowly release air by gently pressing on the tire

valve stem with the edge of your tire gauge until you get to the correct pressure.

- Step 4: If the tire pressure is too low, note the difference between the measured tire pressure and the correct tire pressure. These “missing” pounds of pressure are what you will need to add.
- Step 5: At a service station, add the missing pounds of air pressure to each tire that is underinflated.
- Step 6: Check all the tires to make sure they have the same air pressure (except in cases in which the front and rear tires are supposed to have different amounts of pressure).

If you have been driving your vehicle and think that a tire is underinflated, fill it to the recommended cold inflation pressure indicated on your vehicle’s tire information placard or certification label. While your tire may still be slightly underinflated due to the extra pounds of pressure in the warm tire, it is safer to drive with air pressure that is slightly lower than the vehicle manufacturer’s recommended cold inflation pressure than to drive with a significantly underinflated tire. Since this is a temporary fix, don’t forget to recheck and adjust the tire’s pressure when you can obtain a cold reading.

2.3.6. TIRE SIZE

To maintain tire safety, purchase new tires that are the same size as the vehicle’s original tires or another size recommended by the manufacturer. Look at the tire information placard, the owner’s manual, or the sidewall of the tire you are replacing to find this information. If you have any doubt about the correct size to choose, consult with the tire dealer.

2.3.7. TIRE TREAD

The tire tread provides the gripping action and traction that prevent your vehicle from slipping or sliding, especially when the road is wet or icy. In general, tires are not safe and should be replaced when the tread is worn down to 1/16 of an inch. Tires have built-in treadwear indicators that let you know when it is time to replace your tires. These indicators are raised sections spaced intermittently in the bottom of the tread grooves. When they appear “even” with the outside of the tread, it is time to replace your tires. Another method for checking tread depth is to place a penny in the tread with Lincoln’s head upside down and facing you. If you can see the top of Lincoln’s head, you are ready for new tires.

2.3.8. TIRE BALANCE AND WHEEL ALIGNMENT

To avoid vibration or shaking of the vehicle when a tire rotates, the tire must be properly balanced. This balance is achieved by positioning weights on the wheel to counterbalance heavy spots on the wheel-and-tire assembly. A wheel alignment adjusts the angles of the wheels so that they are positioned correctly relative to the vehicle’s frame. This adjustment maximizes the life of your tires. These adjustments require special equipment and should be performed by a qualified technician.

2.3.9. TIRE REPAIR

The proper repair of a punctured tire requires a plug for the hole and a patch for the area inside the tire that surrounds the puncture hole. Punctures through the tread can be repaired if they are not too large, but punctures to the sidewall should not be repaired. Tires must be removed from the rim to be properly inspected before being plugged and patched.

2.3.10. TIRE FUNDAMENTALS

Federal law requires tire manufacturers to place standardized information on the sidewall of all tires. This information identifies and describes the fundamental characteristics of the tire and also provides a tire identification number for safety standard certification and in case of a recall.

2.3.10.1. Information on Passenger Vehicle Tires

Please refer to the diagram below.

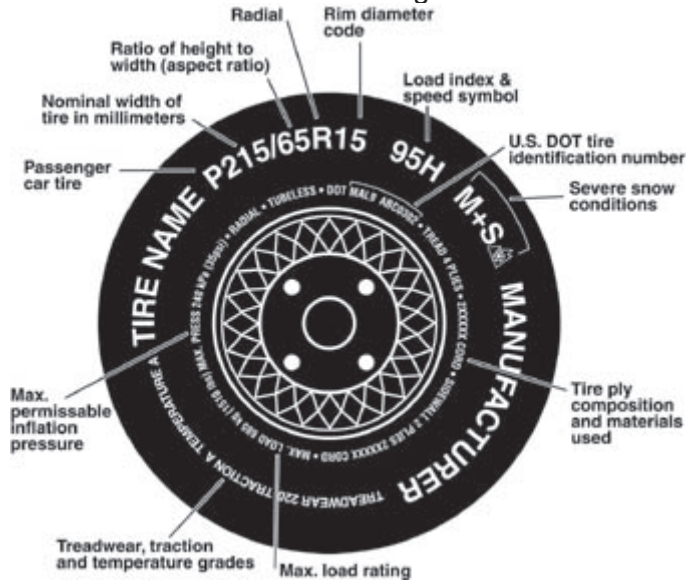

P
The “P” indicates the tire is for passenger vehicles.

Next number
This three-digit number gives the width in millimeters of the tire from sidewall edge to sidewall edge. In general, the larger the number, the wider the tire.

Next number
This two-digit number, known as the aspect ratio, gives the tire’s ratio of height to width. Numbers of 70 or lower indicate a short sidewall for improved steering response and better overall handling on dry pavement.

R
The “R” stands for radial. Radial ply construction of tires has been the industry standard for the past 20 years.

Next number
This two-digit number is the wheel or rim diameter in inches. If you change your wheel size, you will have to purchase new tires to match the new wheel diameter.

Next number
This two- or three-digit number is the tire’s load index. It is a measurement of how much weight each tire can support. You may find this information in your owner’s manual. If not, contact a local tire dealer. Note: You may not find this information on all tires because it is not required by law.

M+S
The “M+S” or “M/S” indicates that the tire has some mud and snow capability. Most radial tires have these markings; hence, they have some mud and snow capability.

U.S. DOT Tire Identification Number
This begins with the letters “DOT” and indicates that the tire meets all federal standards. The next two numbers or letters are the plant code where it was manufactured, and the last four numbers represent the week and year the tire was built. For example, the numbers 3197 means the 31st week of 1997. The other numbers are marketing codes used at the manufacturer’s discretion. This information is used to contact consumers if a tire defect requires a recall.

Tire Ply Composition and Materials Used

The number of plies indicates the number of layers of rubber-coated fabric in the tire. In general, the greater the number of plies, the more weight a tire can support. Tire manufacturers also must indicate the materials in the tire, which include steel, nylon, polyester, and others.

Maximum Load Rating

This number indicates the maximum load in kilograms and pounds that can be carried by the tire.

Maximum Permissible Inflation Pressure

This number is the greatest amount of air pressure that should ever be put in the tire under normal driving conditions.

2.3.10.2. UTQGS Information

Treadwear Number

This number indicates the tire's wear rate. The higher the treadwear number is, the longer it should take for the tread to wear down. For example, a tire graded 400 should last twice as long as a tire graded 200.

Traction Letter

This letter indicates a tire's ability to stop on wet pavement. A higher graded tire should allow you to stop your car on wet roads in a shorter distance than a tire with a lower grade. Traction is graded from highest to lowest as "AA," "A," "B," and "C".

Temperature Letter

This letter indicates a tire's resistance to heat. The temperature grade is for a tire that is inflated properly and not overloaded. Excessive speed, underinflation or excessive loading, either separately or in combination, can cause heat build-up and possible tire failure. From highest to lowest, a tire's resistance to heat is graded as "A", "B", or "C".

2.3.10.3. Additional Information on Light Truck Tires

Please refer to the following diagram.

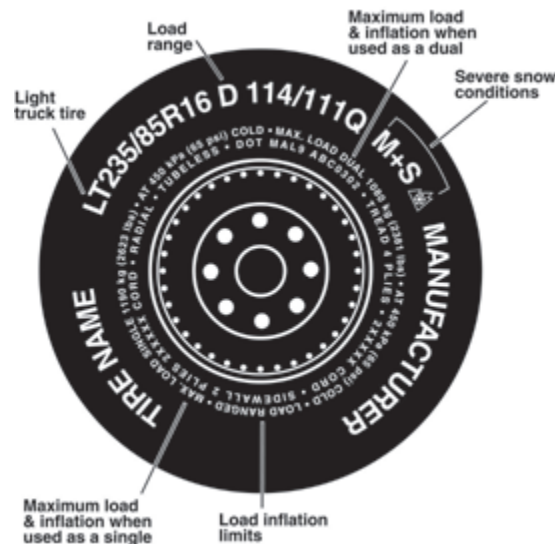

Tires for light trucks have other markings besides those found on the sidewalls of passenger tires.

LT

The "LT" indicates the tire is for light trucks or trailers.

ST

An "ST" is an indication the tire is for trailer use only.

Max. Load Dual kg (lbs) at kPa (psi) Cold

This information indicates the maximum load and tire pressure when the tire is used as a dual, that is, when four tires are put on each rear axle (a total of six or more tires on the vehicle).

Max. Load Single kg (lbs) at kPa (psi) Cold

This information indicates the maximum load and tire pressure when the tire is used as a single.

Load Range

This information identifies the tire's load-carrying capabilities and its inflation limits.

2.3.11. TIRE SAFETY TIPS**Preventing Tire Damage**

- Slow down if you have to go over a pothole or other object in the road.
- Do not run over curbs or other foreign objects in the roadway, and try not to strike the curb when parking.

Tire Safety Checklist

- Check tire pressure regularly (at least once a month), including the spare.
- Inspect tires for uneven wear patterns on the tread, cracks, foreign objects, or other signs of wear or trauma.
- Remove bits of glass and foreign objects wedged in the tread.
- Make sure your tire valves have valve caps.
- Check tire pressure before going on a long trip.
- Do not overload your vehicle. Check the Tire Information and Loading Placard or User's Manual for the maximum recommended load for the vehicle.

3. COUPLING TO THE TOW VEHICLE

Follow all of the safety precautions and instructions in this manual to ensure safety of persons, cargo, and satisfactory life of the trailer.

3.1. USE AN ADEQUATE TOW VEHICLE AND HITCH

If the vehicle or hitch is not properly selected and matched to the Gross Vehicle Weight Rating (GVWR) of your trailer, you can cause an accident that could lead to death or serious injury. If you already have a tow vehicle, know your vehicle tow rating, and Gross Combination Weight Rating (GCWR) and make certain the trailer's rated capacity is less than or equal to the tow vehicle's rated towing capacity. If you already have (or plan to buy) a trailer, make certain that the tow rating of the tow vehicle is equal to or greater than the GVWR of the trailer, and that the GCWR will be within limits.

DANGER

Use of a hitch with a load rating less than the load rating of the trailer can result in loss of control and may lead to death or serious injury.

Use of a tow vehicle with a towing capacity less than the load rating of the trailer can result in loss of control, and may lead to death or serious injury.

Be sure your hitch and tow vehicle are rated for the Gross Vehicle Weight Rating of your trailer.

3.1.1. TRAILER INFORMATION

3.1.1.1. Certification / VIN Label : LOCATED C/S FRONT OF TRAILER

TOP OF LABEL SHEET

MFD BY: LOOK TRAILERS DATE: 03/2010

GVWR: 1356 KG (2990 LB) GAWR (EACH AXLE): 1356 KG (2990 LB)

TIRE ST205/D15 RIM 15" X 5" COLD INFLATION PRESSURE 345 KPA (50 PSI) SGL/DUAL

THIS VEHICLE CONFORMS TO ALL APPLICABLE U.S. FEDERAL MOTOR VEHICLE SAFETY STANDARDS IN EFFECT ON THE DATE OF MANUFACTURE SHOWN ABOVE.

V.I.N. 53BTB1210BU000001 TRAILER EWLC 6X12 S12

TIRE AND LOADING INFORMATION

The weight of cargo should never exceed
676 kg or 1,490 lbs.

TIRE	SIZE	COLD TIRE PRESS.
REAR	ST205/D15	345 KPA (50 PSI)
INTER		
FRONT		
SPARE	NONE	

SEE OWNER'S MANUAL FOR ADDITIONAL INFORMATION

53BTB1210BU000001

FOR REORDER
CALL PMCS
818-957-5649
PART NO. LS-CL-D

BOTTOM OF LABEL SHEET

3.1.1.2. Certification / VIN tag contains the following critical safety information for the use of your trailer:

- **MANUFACTURER:** Name of trailer manufacturer
- **DATE OF MANUFACTURE:** Month and year the trailer was manufactured.
- **GVWR:** The Gross Vehicle Weight Rating is the maximum allowable gross weight of the trailer and its contents. The gross weight of the trailer includes the weight of the trailer and all of the items within it (such as cargo, water, food and other supplies).
- **GAWR:** The Gross Axle Weight Rating is the maximum gross weight that an axle can support. It is the lowest of axle, wheel, or tire rating. Sometimes the tire or wheel rating is lower than the axle manufacturers rating, and will then determine GAWR.

The sum total of the GAWR for all trailer axles may be less than the GVWR for the trailer, because some of the trailer load is carried by the tow vehicle, rather than by the trailer axle(s). The total weight of the cargo and trailer must not exceed the GVWR, and the load on an axle must not exceed its GAWR.

- **TIRE SIZE:** The tire size recommended for your trailer and load range.
- **PSIC:** The “pounds per square inch- cold” is the tire pressure (Kilopascals / Pounds per Square Inch) measured when Cold.
- **CERTIFICATION STATEMENT:** “This trailer meets all the Federal Motor Vehicle Safety Standards in effect on the date of manufacture shown above”.
- **VIN:** The Vehicle Identification Number.
- **VEHICLE TYPE:** Generally the word “trailer” is used. However, after this you may put a Model #, or additional descriptor.

3.2. COUPLING AND UNCOUPLING THE TRAILER

A secure coupling (or fastening) of the trailer to the tow vehicle is essential. A loss of coupling may result in death or serious injury. Therefore, you must understand and follow all of the instructions for coupling.

The following parts are involved in making a secure coupling between the trailer and tow vehicle:

Coupling: That part of the trailer connecting mechanism by which the connection is actually made to the trailer hitch. This does not include any structural member, extension of the trailer frame, or brake controller.

Hitch: That part of the connecting mechanism including the ball support platform and ball and those components that extend and are attached to the towing vehicle, including bumpers intended to serve as hitches.)

- **Weight Distributing Hitch (or Equalizing Hitch):** A mechanical device that connects the trailer to the towing vehicle and by means of leverage applied on both the trailer and towing vehicle structures, when properly adjusted, distributes the imposed vertical load at the hitch and coupling connection between structures of the towing vehicle and trailer.
- **Weight Carrying Hitch:** A mechanical and/or structural device that connects the trailer to the towing vehicle and that does not employ features designed to redistribute the load imposed at the hitch and carrying connection.

Safety chains or cables: Chains or cables permanently attached to the trailer such that if the coupler connection comes loose, the safety chains or cables can keep the trailer attached to the tow vehicle. With properly rigged safety chains or cables, it is possible to keep the tongue of the trailer from digging into the road pavement, even if the coupler-to-hitch connection comes apart.

Some states may not allow safety cables. Therefore it may be wise to check with the State Police to see if your state has any restrictions on the use of safety cables, if your trailer is so equipped.

Trailer lighting (and braking) connector: A device that connects electrical power from the tow vehicle to the trailer. Electricity is used to turn on brake lights, running lights, and turn signals as required. In addition, if your trailer has a separate braking system, the electrical connector will also supply power to the trailer brakes from the tow vehicle.

Breakaway switch: If the trailer becomes de-coupled from the towing vehicle, the breakaway switch lanyard, attached independently to the tow vehicle hitch, will pull a pin in the emergency electrical break-away switch on the trailer. The breakaway switch is activated by a separate battery supply in the trailer such as to energize the trailer brakes independently of the towing vehicle. It is important to check the state of charge of the emergency break-away battery before each trip. Simply pull the pin out of the switch by hand and then try to pull the trailer. If you feel a significant drag force the brakes are activated. Be sure to re-insert the pin in the break-away switch. Also be sure to allow enough slack in the break-away brake lanyard such that the switch will only activate (pin pulls out) if the coupler connection comes loose. For additional details refer to Section 3.2.2.7

Jack: A device on the trailer that is used to raise and lower the trailer tongue. On larger trailers the jack is sometimes called the “landing gear.”

3.2.1. VARIOUS COUPLER DESIGNS

Trailers are produced with a variety of coupler devices. One of the sections below will pertain to your trailer.

- Bumper pull (Ball Hitch) Coupler
- Gooseneck Hitch Coupler
- Fifth Wheel Coupler

If the coupler on your trailer does not resemble one of the couplers shown in the figures, see the separate coupler instructions. If you do not have these instructions, call Pace American at 877-475-5665 for a free copy.

3.2.2. TRAILER WITH BALL-HITCH COUPLER

A ball hitch coupler connects to a ball that is located on or under the rear bumper of tow vehicle. This system of coupling a trailer to a tow vehicle is sometimes referred to as “bumper pull.”

A ball hitch trailer may be fitted with a tongue jack that can raise and lower the coupler. The tongue jack is mounted to the A-frame (front, or tongue) part of the trailer. By rotating the jack handle clockwise, the jack will extend and raise the tongue of the trailer.



Be sure the Ball Hitch coupler is suitable for the size and weight of the trailer. The load rating of the coupler and the necessary ball size are listed on the trailer tongue. You must provide a hitch and ball for your tow vehicle, where the load rating of the hitch and ball is equal to or greater than that of your trailer. Also, the ball size must be the same as the coupler size. If the hitch ball is too small, too large, is underrated, is loose or is worn, the trailer can come loose from the tow vehicle, and may cause death or serious injury.

THE TOW VEHICLE, HITCH AND BALL MUST HAVE A RATED TOWING CAPACITY EQUAL TO OR GREATER THAN THE TRAILER GROSS VEHICLE WEIGHT RATING (GVWR).

IT IS ESSENTIAL THAT THE HITCH BALL BE OF THE SAME SIZE AS THE COUPLER.

The ball size and load rating (capacity) are marked on the ball; hitch capacity is marked on the hitch.

3.2.2.1. Before coupling the trailer to the tow vehicle

Be sure the size and rating of hitch ball match the size and rating of the coupler. Hitch balls and couplers are marked with their size and rating.

Wipe the hitch ball clean and inspect it visually and by feel for flat spots, cracks and pits.

Rock the ball to make sure it is tight to the hitch, and visually check that the hitch ball nut is solid against the lock washer and hitch frame.

Wipe the inside and outside of the coupler clean and inspect it visually for cracks and deformations; feel the inside of the coupler for worn spots and pits.

Be sure the coupler is tight to the tongue of the trailer. All coupler fasteners must be visibly solid against the trailer frame.

Raise the bottom surface of the coupler to be above the top of the hitch ball. Use the jack if one is provided; otherwise, use wood or concrete blocks to support the trailer tongue.

3.2.2.2. Before attempting to tow the trailer

Be sure all deadbolt locks are engaged.

⚠ WARNING

Engage deadbolt lock when towing trailer to prevent accidental door opening while in transit.

3.2.2.3. Prepare the coupler and hitch

Lubricate the hitch ball and the inside of the coupler with a thin layer of automotive bearing grease. If your trailer is equipped with a jack, raise the coupler above the ball height.

Open the coupler locking mechanism. Ball couplers have a locking mechanism with an internal moving piece (ball clamp) and an outside handle, wheel, or latch.

In the open position, the coupler is able to drop fully onto the hitch ball.
See the coupler instructions for details of placing the coupler in the “open” position.

Slowly back up the tow vehicle so that the hitch ball is near or aligned under the coupler, if the trailer jack has raised the coupler.

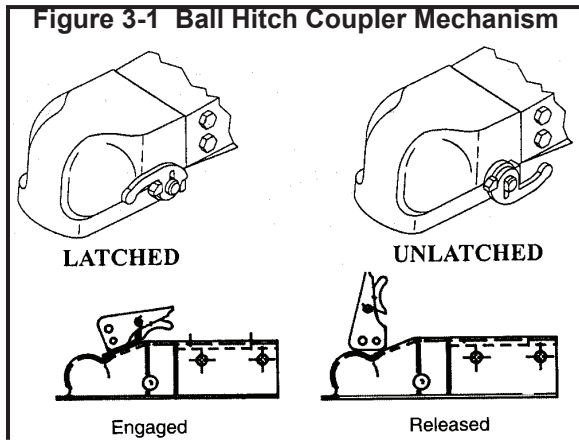

3.2.2.4. Couple the trailer to the tow vehicle

With your jack, lower the trailer tongue until the coupler fully engages the hitch ball. If the coupler does not line up with the hitch ball, adjust the position of the tow vehicle.

Engage the coupler locking mechanism. In the engaged position, the locking mechanism securely holds the coupler to the hitch ball.

Insert a pin or lock through the hole in the locking mechanism.

Be sure the coupler is all the way on the hitch ball and the locking mechanism is engaged. A properly engaged locking mechanism will allow the coupler to raise the rear of the tow vehicle. Using the trailer jack, test to see that you can raise the rear of the tow vehicle by 1 inch, after the coupler is locked to the hitch

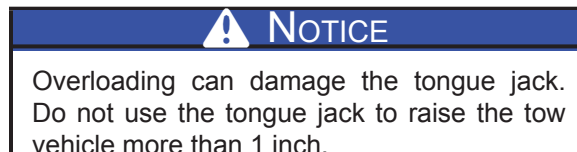

If the coupler cannot be secured to the hitch ball, do not tow the trailer. Call 877-475-5665 at Pace American or your dealer for assistance.

Lower the trailer so that its entire tongue weight is held by the hitch, and continue retracting the jack to its fully retracted position. Be sure to fully retract the tongue jack before towing.

3.2.2.5. Adjust Hitch Height (If Equipped)

The height of the hitch on the trailer must be adjusted so that the trailer, when loaded to rated capacity, is level while connected to the tow vehicle.

A wider wheelbase on a spread axle lends itself to a trailer that is harder to turn and less receptive to lateral inputs from the tow vehicle and more receptive to external factors. The trailer can start to “wander” with imperfect road conditions, strong winds, alignment issues, and air under the trailer.

If your trailer is equipped with spread axles (48” O.C.), the trailer must be 1-2” tongue high when hooked up to the tow vehicle. An anti-sway kit is also recommended for speeds in excess of 55MPH.

Your dealer or a trailer service center can perform this adjustment or you can use the following steps to adjust the hitch height yourself.

If the trailer is not equipped with an adjustable hitch, an offset ball mount may be available from your hitch manufacturer.

 WARNING
Improper hitch height adjustment can result in overloaded tires, blowout and loss of control, leading to death or serious injury.
Adjust the hitch height so that the loaded trailer is level.

1. Connect trailer to tow vehicle and load the trailer to rated capacity.
2. Park the tow vehicle and trailer on a firm level surface.
3. Stand away from the trailer and physically verify with a tape measure if the trailer is level front-to-rear. If the front of the trailer is higher than the rear, the trailer hitch must be raised. If the front of the trailer is lower than the rear, the trailer hitch must be lowered.
4. Uncouple trailer from tow vehicle.
5. Remove the lock nuts and bolts (1) on hitch. Discard lock nuts. Inspect bolts for damage and replace if necessary. Contact your dealer for the correct size, grade of bolts/nuts and torque specs.

 WARNING
Used lock nuts are prone to loosen, resulting in the hitch separating from the trailer, which can lead to death or serious injury.
NEVER re-use a lock nut.
Use new lock nuts each time the hitch height is adjusted.
Contact your dealer for the proper grade and size of lock nut.

6. Raise or lower the hitch as necessary.
7. Install bolts and new lock nuts.
8. Tighten lock nuts to torque specified by your dealer.
9. Couple the trailer to the tow vehicle and physically verify with a tape measure that the trailer is level front to rear. Adjust if necessary.
10. Unload trailer.

3.2.2.6. Rig the Safety Chains



Visually inspect the safety chains and hooks for wear or damage. Replace worn or damaged safety chains and hooks before towing.

Rig the safety chains so that they:

- Cris-cross underneath the coupler so if the trailer uncouples, the safety chains can hold the tongue up above the road.

- Loop around a frame member of the tow vehicle or to holes provided in the hitch system (but, do not attach them to an interchangeable part of the hitch assembly)

- Attach “S” hooks up from underneath the hole (do not just drop into hole)

- Make sure the safety latches on the safety chains are fully engaged when attached to the tow vehicle; and

- Provide enough slack to permit tight turns, but not be close to the road surface to drag.

3.2.2.7. Attach and test electric breakaway brake system

If the coupler or hitch fails, a properly connected and working breakaway brake system will apply electric brakes on the trailer. The safety chains will keep the tow vehicle attached and as the brakes are applied at the trailer’s axles, the trailer/tow vehicle combination will come to a controlled stop.

The breakaway brake system includes a battery, a switch with a pullpin, and a lanyard. Read and follow the instructions here as well as the instructions that have been prepared by the breakaway brake manufacturer. If you do not have these instructions, call 877-475-5665 at Pace American for a free copy.

The breakaway brake system is not fitted with a “charging” capability that draws power from the tow vehicle. You must periodically charge the battery to keep the breakaway brake system in working order.



Connect the pullpin lanyard to the tow vehicle so that the pullpin will be pulled out before all of the slack in the safety chains is taken up (see Breakaway Brake System figure). Do **not** connect the pullpin cable to a safety chain or to the hitch ball or hitch ball assembly. This would keep the breakaway brake system from operating when it is needed.

To test the break-away brake battery, remove the pullpin from the switch and attempt to pull the trailer forward. You should feel the trailer resisting being towed, but the wheels will not necessarily be locked. If the brakes do not function, do not tow the trailer until brakes, or battery, are repaired.

Immediately replace the pullpin. The breakaway brake system battery discharges rapidly when the pullpin is removed.

Do **not** tow the trailer with the breakaway brake system ON because the brakes will overheat which can result in permanent brake failure.

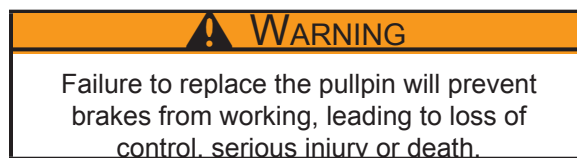

If you do not use your trailer for three or more months, or during winter months:

- Store the battery indoors; and
- Charge the battery every three months.

Replace the breakaway brake battery according to the intervals specified by battery manufacturer.

3.2.2.8. Connect the electrical cables

Connect the trailer lights to the tow vehicle's electrical system using the electrical connectors.

Check all lights for proper operation.

Clearance and Running Lights (Turn on tow vehicle headlights).

Brake Lights (Step on tow vehicle brake pedal).

Turn Signals (Operate tow vehicle directional signal lever).

Check electric brakes for proper operation using brake controller mounted in the cab.

If your trailer has electric brakes, your tow vehicle may have an electric brake controller that sends power to the trailer brakes. Before towing the trailer on the road, you must operate the brake controller while trying to pull the trailer in order to confirm that the electric brakes operate. While towing the trailer at less than 5 m.p.h., manually operate the electric brake controller in the tow vehicle cab. You should feel the operation of the trailer brakes.

3.2.2.9. Uncoupling the Ball Hitch Trailer with Tongue Jack

Follow these steps to uncouple your ball hitch trailer from the tow vehicle:

- Block trailer tires to prevent the trailer from rolling, before jacking the trailer up.
- Disconnect the electrical connector.
- Disconnect the breakaway brake switch lanyard.
- Disconnect the safety chains from the tow vehicle.
- Unlock the coupler and open it.
- Before extending jack, make certain the ground surface below the jack pad will support the tongue load.
- Rotate the jack handle (or crank) clockwise. This will slowly extend the jack and transfer the weight of the trailer tongue to the jack.

3.2.3. TRAILER WITH GOOSENECK COUPLER AND DROP-LEG JACK

A gooseneck coupler on the trailer connects to a gooseneck ball that you must have installed in the bed of the tow vehicle. This system of coupling a trailer to a tow vehicle permits the tow vehicle to turn to sharper angles than are permitted by a bumper hitch system. A gooseneck coupler consists of a tube in an inverted “U” shape and a gooseneck ball receiver.

We have installed a Gooseneck ball receiver that is suitable for the size and weight of the trailer. The load rating of the coupler and the necessary ball size are listed on the gooseneck.

You must provide a gooseneck ball and support structure that is marked with a rating that meets or exceeds the GVWR of your trailer and matches the size of the gooseneck ball receiver. If the gooseneck ball is too small, is underrated, is loose or is worn, the trailer can come loose from the tow vehicle, and may lead to death or serious injury.

THE TOW VEHICLE, SUPPORT STRUCTURE AND GOOSENECK BALL MUST HAVE A RATED TOWING CAPACITY EQUAL TO OR GREATER THAN THE TRAILER GROSS VEHICLE WEIGHT RATING (GVWR).

IT IS ESSENTIAL THAT THE GOOSENECK BALL BE OF THE SAME SIZE AS THE GOOSENECK BALL RECEIVER.

The ball size and load rating (capacity) are marked on the ball; hitch capacity is marked on the hitch.

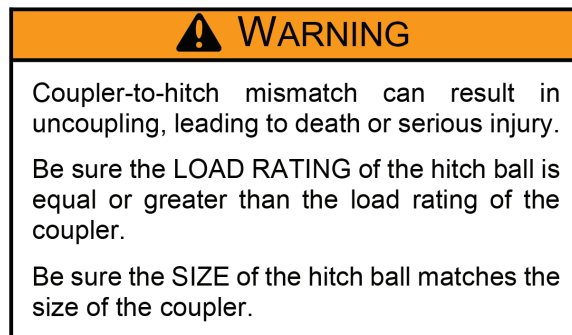

The height of the ball receiver on the trailer must be adjusted to match the height of the gooseneck ball on your tow vehicle, so that there is clearance between the bottom of the trailer and the sides of the tow vehicle bed.

The height of the hitch on the trailer must be adjusted so that the trailer, when loaded to rated capacity, is level

while connected to the tow vehicle.

A wider wheelbase on a spread axle lends itself to a trailer that is harder to turn and less receptive to lateral inputs from the tow vehicle and more receptive to external factors. The trailer can start to “wander” with imperfect road conditions, strong winds, alignment issues, and air under the trailer.

If your trailer is equipped with spread axles (48” O.C.), the trailer must be 1-2” tongue high when hooked up to the tow vehicle. An anti-sway kit is also recommended for speeds in excess of 55MPH.

The “Gooseneck Ball Receiver and Height Adjustment” figure shows the gooseneck height adjustment. The gooseneck height adjustment bolts, which have a “cup” that makes a gripping impression into the gooseneck tube, must be tight so that the trailer does not drop to a lower position. Do not over-tighten because the tube can be deformed. After tightening the bolts, tighten the jam nuts on the bolts.

*Some couplers may use a hitch pin with clip instead of a bolt. Be sure to insert retaining clip into pin before use.

Some couplers are equipped with a set screw(s). This screw(s) must be tightened once the height is determined and the height adjustment bolt/pin is installed.

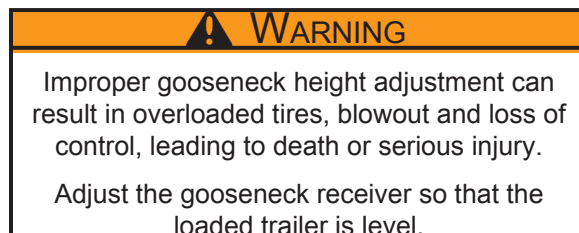
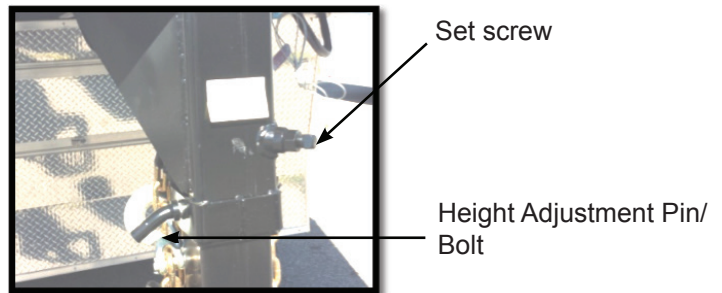

A trailer having a gooseneck hitch will have one or two drop leg jacks for raising and lowering the gooseneck ball receiver. Because several drop leg jack mechanisms are available, the general instructions below may vary slightly from the jack manufacturer’s instructions.

Before attempting to tow the trailer:

Be sure the size and rating of the gooseneck ball match the size and rating of the receiver. Gooseneck balls and receivers are marked with their size and ratings.

Wipe the gooseneck ball clean and inspect it visually and by feel for flat spots, cracks and pits.

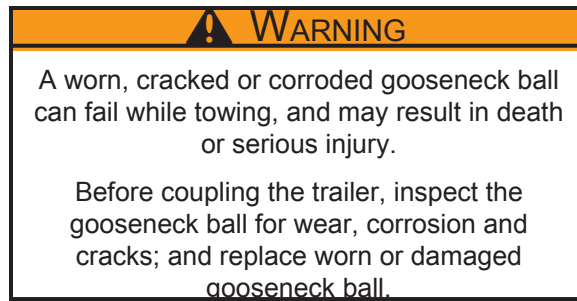

Rock the ball to make sure it is tight to the ball support, and visually check that the gooseneck ball nut is solid against the lock washer and ball support frame.

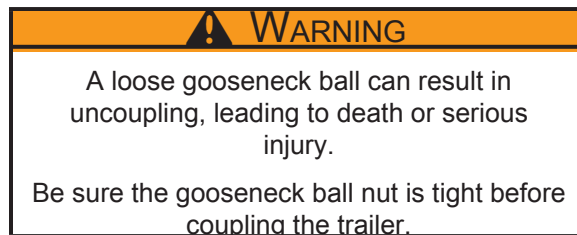

Wipe the inside and outside of the receiver clean and inspect it visually for cracks; and feel the inside of the receiver for worn spots and pits. If any of these conditions exist, have the receiver replaced before coupling the trailer.

Lubricate the inside of the gooseneck ball receiver with automotive bearing grease. Be sure the receiver is tight to the trailer. All receiver fasteners must be visibly solid against the trailer frame.

Release the jack handle or crank from its holder (see “Drop Leg Jack” figure).

Make certain the ground beneath the jack foot is firm enough to support the tongue weight.

Rotate the handle/crank clockwise to raise the bottom surface of the gooseneck to be above the top of the gooseneck ball.

3.2.3.1. Prepare the ball receiver and gooseneck ball

Release the lock plate on the gooseneck ball receiver. With the spring-loaded lock plate locking pin in the OPEN position, rotate the lock plate to a position that allows the gooseneck ball to enter the receiver (see “Gooseneck Ball Receiver and Height Adjustment” figure).

Slowly back up the tow vehicle so that the gooseneck ball is aligned under the gooseneck ball receiver.

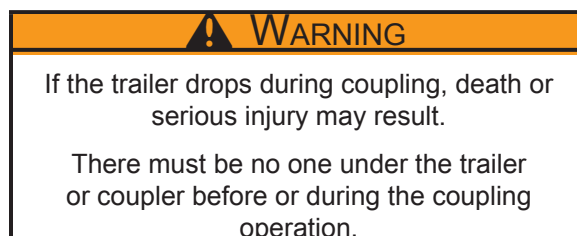

3.2.3.2. Couple the trailer to the tow vehicle

Rotate the jack handle counter-clockwise. This will retract the jack causing the gooseneck ball receiver to drop down so it can fully engage the gooseneck ball and transfer the weight of the trailer tongue to the towing vehicle hitch. If the receiver does not line up with the ball, raise the receiver again and adjust the

position of the tow vehicle. Then lower the receiver over the ball. When the drop leg base is no longer resting on the ground, the towing vehicle hitch is holding all of the weight of the trailer tongue.

Close the lock plate on the gooseneck ball receiver.

Move the spring-loaded lock plate locking pin to the CLOSED position. Be sure the locking pin is holding the lock plate.

Be sure the receiver is all the way on the gooseneck ball and the lock plate is engaged. A properly engaged locking mechanism will allow the coupler to raise the rear of the tow vehicle. Using the trailer jack, test to see that you can raise the rear of the tow vehicle by 1 inch.

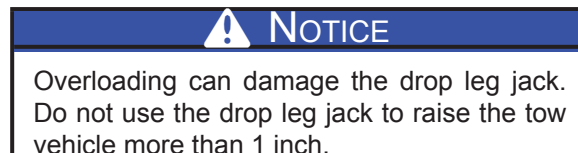

If the gooseneck ball cannot be secured to the receiver, do not tow the trailer. Call Pace American at 877-475-5665 or your dealer for assistance.

After testing to see that the receiver is properly secured and locked to the ball, retract the jack to its fully retracted position.

Return the drop legs to their upper positions. The drop legs are held in place with a plunger pin. Rotating the plunger pin while pulling it outward will cause it to come out of engagement with the drop leg.

3.2.3.3. Rig the safety chains

Visually inspect the safety chains and hooks for wear or damage. Replace worn or damaged safety chains and hooks before towing.

Rig the safety chains so that they attach to the "safety chain receivers" in the bed of the truck. If you are not certain of the hitch provisions for receiving safety chains, contact the hitch manufacturer or installer. **DO NOT** attach the safety chains to the gooseneck ball or its support; and

Rig the safety chains so they have sufficient slack to permit turning, but not too much slack – the safety chains must keep the gooseneck on the tow vehicle bed if the trailer uncouples.

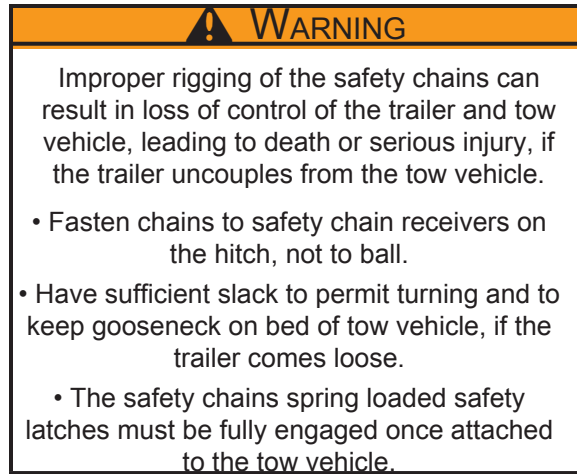

3.2.3.4. Attach and test the breakaway brake system

If the coupler or hitch fails, a properly connected and working breakaway brake system will apply electric brakes on the trailer. The safety chains will keep the tow vehicle attached and as the brakes are applied at the trailer's axles, the trailer/tow vehicle combination will come to a controlled stop.

The breakaway brake system includes a battery, a switch with a pullpin, and a breakaway brake controller. Read and follow the instructions here as well as the instructions that have been prepared by the breakaway brake controller manufacturer. If you do not have these instructions, call 844-475-5665 at Pace American for a free copy.

The breakaway brake system is not fitted with a charging facility that draws power from the tow vehicle. You must periodically charge the battery on the trailer to keep the breakaway brake system in working order.

Visually inspect the breakaway brake system for broken parts.

Connect the pullpin cable to the tow vehicle so that the pullpin will be pulled out before all of the slack in the safety chains is taken up (see "Safety Chains" figure). Do **not** connect the pullpin cable to a safety chain or a safety chain receiver or to the gooseneck ball or its support. This would keep the breakaway brake system from operating when it is needed. Contact the hitch manufacturer or installer if you are not certain of the hitch provisions for breakaway brake connection

To check the breakaway brake battery, pull out the pullpin from the switch and attempt to pull the trailer forward. You should feel the trailer resisting being towed, but the wheels will not necessarily lock up.

Immediately replace the pullpin. The breakaway brake system battery discharges rapidly when the pullpin is removed.

Do **not** tow the trailer with the breakaway brake system ON because the brakes will overheat which can result in permanent brake failure.

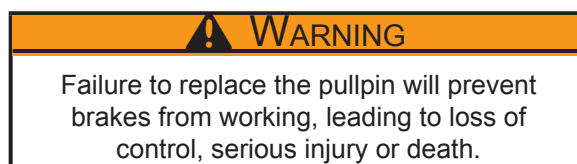

If you do not use your trailer for three or more months, or during winter months:

- Store the battery indoors; and
- Charge the battery every three months.

Replace the breakaway brake battery at intervals recommended by the battery manufacturer's instructions.

3.2.3.5. Before attempting to tow the trailer

Be sure all deadbolt locks are engaged.



3.2.3.6. Connect the electrical cables

Connect the trailer lights to the tow vehicle's electrical system using the electrical connectors.

Check all lights for proper operation:

- Clearance and Running Lights (Turn on tow vehicle headlights).
- Brake Lights (Step on tow vehicle brake pedal).
- Turn Signals (Operate tow vehicle directional signal lever).

Check electric brakes for proper operation

If your trailer has electric brakes, your tow vehicle will have an electric brake controller that sends power to the trailer brakes. Before towing the trailer on the road, you must operate the brake controller while trying to pull the trailer in order to confirm that the electric brakes operate. While towing the trailer at less than 5 m.p.h., manually operate the electric brake controller in the tow vehicle cab. You should feel the operation of the trailer brakes.

3.2.3.7. Uncoupling the Gooseneck Trailer with Drop-leg Jack

Follow these steps to uncouple your gooseneck hitch trailer from the tow vehicle:

- Block trailer tires to prevent the trailer from rolling, before jacking the trailer up
- Disconnect the electrical connector.
- Disconnect the breakaway brake switch lanyard.
- Disconnect the safety chains from the tow vehicle.
- Move the spring-loaded gooseneck receiver lock plate locking pin to the OPEN position (see "Gooseneck Ball Receiver and Height Adjustment" figure).
- Rotate the lock plate to a position that permits the gooseneck ball to exit the receiver.
- Before releasing dropleg jack, make certain ground surface below jack base will support the trailer tongue load.
- Rotate the drop leg plunger pin handle so that the plunger pin is released from the drop leg.
- Keep feet and hands clear of drop leg base.
- Rotate the plunger pin handle so that the plunger pin is attempting to disengage the drop leg.
- Re-engage the plunger pin. Push it in by hand if necessary. The bent part of the plunger pin handle must be touching the plunger pin housing.
- If your trailer has two drop leg jacks, lower them both to the same level, following the above instructions.
- Release the handle (or crank) from its holder and engage it with the jack shaft (see "Drop Leg Jack" figure).
- Rotate the handle (or crank) from its hold and engage it with the jack shaft (see "Drop Leg Jack" figure).
- Rotate the handle (or crank) clockwise to slowly extend the jack and transfer the weight of the trailer tongue to the jack.
- On two speed jacks, pushing the handle shaft toward the gearbox can perform rapid extension. This shifts the gearbox into a high speed mode.
- When the drop leg base contacts the ground, shift the gearbox into low gear mode by pulling or pushing on

the handle shaft until it locks into low gear.

 NOTICE	
Do not use high gear to lift the trailer; the drop leg jack mechanism can be damaged.	
High gear is used only to rapidly move the drop leg base into contact with the ground.	

- Continue to extend the jack(s), making sure that the ground is providing stable and level support for the trailer.
- After the jack(s) are extended and the gooseneck ball receiver is well clear of the gooseneck ball, to permit driving the tow vehicle away, disengage the handle from its shaft and return to its holder.

3.2.4. TRAILER WITH FIFTH-WHEEL COUPLER AND DROP-LEG JACK

A fifth wheel coupler on the trailer (see “Trailer with a Kingpin Coupler” figure 3.1 and “Fifth Wheel Coupler” figure 3.2) connects to a kingpin that is installed on the tow vehicle. A Fifth Wheel Coupler on the tow vehicle (Figure 3.2) connects to a Kingpin that is installed on a trailer.

A fifth wheel coupler includes a flat load-bearing plate with a slot, and a mechanism inside the slot that “grips” the kingpin.

We have installed a fifth wheel coupler that is suitable for the size and weight of the trailer. You must provide a kingpin and kingpin plate that match the fifth wheel, and that is rated for the Gross Vehicle Weight Rating (GVWR) of your trailer.

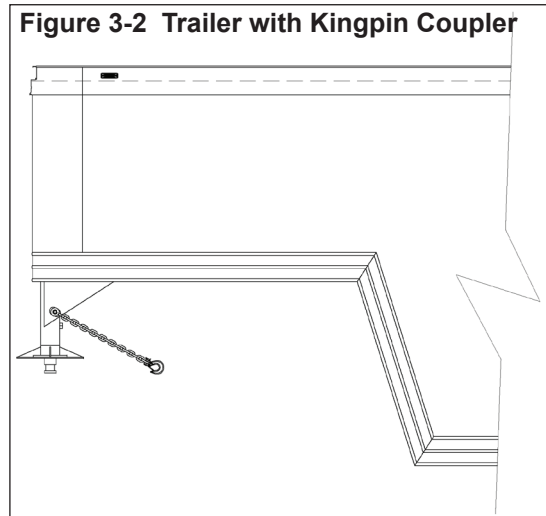
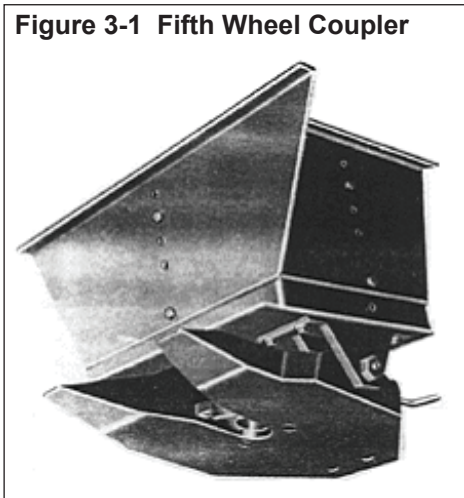

3.2.4.1. Before attempting to tow the trailer

Be sure all deadbolt locks are engaged.

 WARNING	
Engage deadbolt lock when towing trailer to prevent accidental door opening while in transit.	

Be sure the size and rating of the fifth wheel and kingpin match.

Wipe the kingpin clean and inspect it visually and by feel for flat spots, cracks and pits. Check the condition of the kingpin mounting in the bed of the tow vehicle.

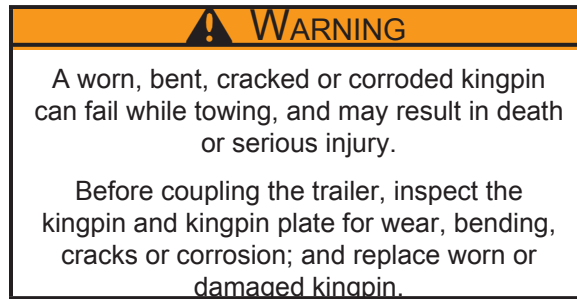

Be sure the fifth wheel mechanism operates freely.

Lubricate the fifth wheel plate surface with a light coat of Lithium-base, waterproof grease.

Be sure the fifth wheel and kingpin fasteners are tight and any welds are solid.

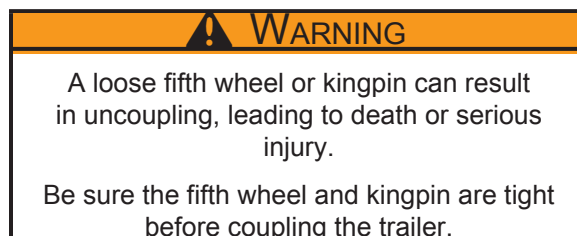

Be sure the brake line, electrical line, and any other lines are clear of the coupling area. Be sure the locks are open (see “Fifth Wheel Coupler Operation” figure).

If the tow vehicle is equipped with a tailgate, lower it.

Block the trailer wheels, front and rear.

Make certain that trailer fifth wheel plate is slightly above the kingpin plate on the tow vehicle.

Back tow vehicle up close to the trailer, centering the kingpin in the slot of the fifth wheel.

STOP before engaging the coupling.

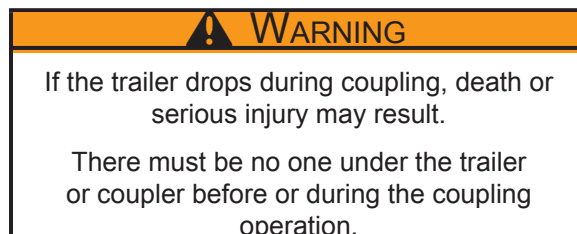

Adjust the height of the trailer, using the jack, so that the fifth wheel plate just touches the kingpin plate.

Slowly back up the tow vehicle, keeping the kingpin centered in the slot of the fifth wheel. Continue backing up until the fifth wheel locks firmly on the kingpin.

Visually check to confirm that the fifth wheel locks are properly locked onto the kingpin by performing the three checks illustrated in the “Fifth Wheel Coupler Operation” figure.

Attempt to pull forward as an initial test of the closing of the fifth wheel locks.

Figure 3-3 Fifth Wheel Coupler Operation

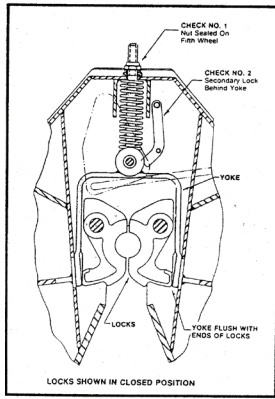

FIGURE 6A

- CHECK 1**
The adjustment nut must be seated against the fifth wheel (see Figure 6A).
- CHECK 2**
The secondary lock must be behind the yoke (see Figure 6A).
- CHECK 3**
The fifth wheel must be flush with the kingpin plate (see Figure 7A).

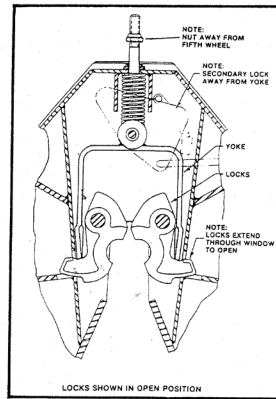

FIGURE 6B

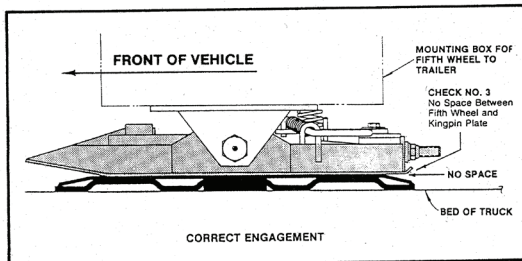

FIGURE 7A

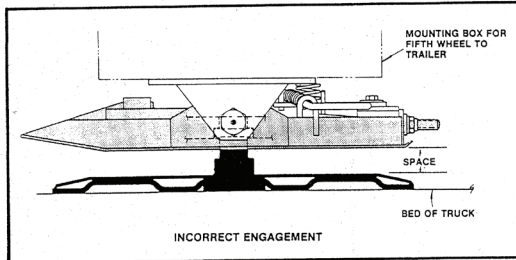

FIGURE 7B

⚠ WARNING

An improperly coupled fifth wheel can come loose, resulting in death or serious injury.

Do not tow the trailer until all of the visual checks have been performed:

- Adjustment nut against fifth wheel.
- Secondary lock behind yoke.
- Fifth wheel against kingpin plate.

3.2.4.2. Raise the Drop Leg Jack

A trailer having a fifth wheel coupler will be outfitted with one or two drop leg jacks for raising and lowering the fifth wheel coupler. Because we use several drop leg jack mechanisms, the general instructions below may vary slightly from the jack manufacturer's instructions. If the trailer jack on your trailer does not resemble the jack shown in the figures, follow the jack instructions provided by the jack manufacturer. If you do not have these instructions, call Pace American at 877-475-5665 for a free copy.

Rotate the jack handle counter-clockwise. This will slowly retract the jack and transfer the weight of the trailer tongue to the towing vehicle. When the drop leg base is no longer resting on the ground, the towing vehicle hitch is holding all of the weight of the trailer tongue. Continue retracting the jack to its fully retracted position.

Return the drop legs to their upper positions. The drop legs are held in the lowered position with a plunger pin. Rotating the plunger pin while pulling it outward about 3/4 inch will cause it to come out of the engagement with the drop leg.

Raise the Tailgate

Pick up the trailer wheel blocks.

3.2.4.3. Attach and test the breakaway brake system

If the coupler fails, a properly connected and working breakaway brake system will apply electric brakes on the trailer.

The breakaway brake system includes a battery, a switch with a pullpin, and a breakaway brake lanyard. Read and follow the instructions here as well as the instructions that have been prepared by the breakaway brake controller manufacturer. If you do not have these instructions, call 877-475-5665 at Pace American for a free copy.

The breakaway brake system is not fitted with a charging facility that draws power from the tow vehicle. You must periodically charge the battery to keep the breakaway brake system in working order.

Visually inspect the breakaway brake system for broken parts.

Connect the pullpin cable to the tow vehicle. Do **not** connect to kingpin or its support.

To test the break-away battery remove the pullpin from the switch and attempt to pull the trailer forward. You should feel the trailer resisting being towed, but the wheels will not necessarily lock-up.

Immediately replace the pullpin. The breakaway brake system battery discharges rapidly when the pullpin is removed.

Do **not** tow the trailer with the breakaway brake system ON because the brake will overheat which can result in permanent brake failure.

If you do not use your trailer for three or more months, or during winter months:

Store the battery indoors; and
Charge the battery every three months.

Replace the breakaway brake battery at intervals recommended by the battery manufacturer

3.2.4.4. Connect the electrical cables

Connect the trailer lights to the tow vehicle's electrical system using the electrical connectors. Check all lights for proper operation:

Clearance and Running Lights (Turn on tow vehicle headlights).
Brake Lights (Step on Tow vehicle brake pedal).
Turn Signals (Operate tow vehicle directional signal lever).

Check brakes for proper operation: While towing the trailer at less than 5 m.p.h., manually operate the electric brake controller in the tow vehicle cab. You should feel the operation of the trailer brakes.

3.2.4.5. Uncoupling the Fifth-Wheel Trailer with Drop-leg Jack

Follow these steps to uncouple your fifth wheel hitch trailer from your tow vehicle

- Block trailer tires to prevent the trailer from rolling before jacking the trailer up.
- Disconnect the electrical connector.
- Disconnect the breakaway brake switch lanyard.
- If the tow vehicle has a tailgate, lower it.
- Make certain that ground surface below jack base will support trailer tongue load.
- Rotate the drop leg plunger pin handle so that the plunger pin is released from the drop leg.
- Keep feet and hands clear of the drop leg it will drop to the ground.

- Rotate the plunger pin handle so that the plunger pin engaged.
- Slowly raise your foot, permitting the drop leg to raise. The plunger pin will engage a hole in the drop leg.
- Be sure the plunger pin is fully engaged. Push it in by hand if necessary. The bent part of the plunger pin handle must be touching the plunger pin housing.
- If your trailer has two drop leg jacks, lower them both to the same level, following the above instructions.

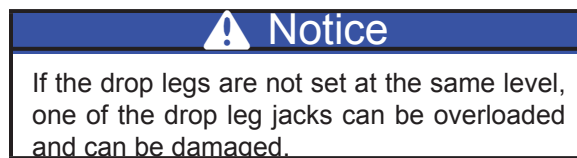

- Release the handle (or crank) from its holder and engage it with the jack shaft.
- Rotate the handle (or crank) clockwise to slowly extend the jack and transfer the weight of the trailer tongue to the jack.
- On two speed jacks, pushing the handle shaft toward the gearbox can perform rapid extension. This shifts the gearbox into a high speed mode.
- When the drop leg base contacts the ground, shift the gearbox into low speed mode by pulling out on the handle shaft until it locks into low gear.

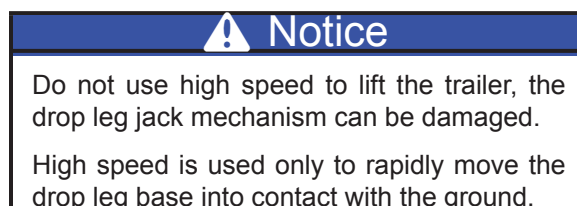

- Continue to extend the jack(s), making sure that the ground is providing stable and level support for the trailer.
- Turn the crank two or three turns to take some of the weight of the coupling. Do **not** raise the fifth wheel off the kingpin plate.
- After the jack(s) are extended enough to permit driving the tow vehicle away, disengage the jack handle from its shaft and return it to its holder. Do NOT drive the tow vehicle yet!

Open the fifth wheel locks by:

- pulling the release handle, or
- using a separate pipe release handle to engage the solid stud on the secondary lock (see “Fifth Wheel Coupler Operation” and “Opening Fifth Wheel Locks” figures).

Slowly drive the tow vehicle away from the trailer.

Raise the tow vehicle tailgate.

4. LOADING THE TRAILER

Improper trailer loading causes many accidents and deaths. To safely load a trailer, you must consider:

- Overall load weight;
- Load weight distribution;
- Proper tongue weight; and
- Securing the load properly.

To determine that you have loaded the trailer within its rating, you must consider the *distribution* of weight, as well as the total weight of the trailer and its contents. The trailer axles carry most of the total weight of the trailer and its contents (Gross Vehicle Weight, or “GVW”). The remainder of the total weight is carried by the tow vehicle hitch. It is essential for safe towing that the trailer-tongue and tow vehicle hitch carry the proper amount of the loaded trailer weight, otherwise the trailer can develop an undesirable sway at towing speeds, or the rear of the towing vehicle can be overloaded. Read the “Tongue Weight” section below.

The load distribution must be such that no component part of the trailer is loaded beyond its rating. This means that you must consider the rating of the tires, wheels and axles. For tandem and triple axle trailers, you must make sure that the front-to-rear load distribution does not result in overloading any axle.

Towing stability also depends on keeping the center of gravity as low as possible. Load heavy items on the floor and over the axles. When loading additional items, be sure to maintain even side-to-side weight distribution and proper tongue weight. The total weight of the trailer and its contents must never exceed the total weight rating of the trailer (Gross Vehicle Weight Rating, or “GVWR”).

4.1. TONGUE WEIGHT

It is critical to have a portion of the trailer load carried by the tow vehicle. That is, the trailer tongue must exert a downward force on the hitch. This is necessary for two reasons. First, the proper amount of tongue weight is necessary for the tow vehicle to be able to maintain control of the tow vehicle/trailer system. If, for example, the tongue exerts an upward pull on the hitch, instead of pushing down on it (because the trailer is overloaded behind its axle(s)), the rear wheel of the tow vehicle can lose traction or grip and cause loss of control. Also, even if there is some weight on the tongue, but not enough weight on the tongue, the trailer can become unstable at high speeds. Remember, the faster you go the more likely the trailer is to sway.

If, on the other hand, there is too much tongue weight, the tow vehicle is prone to jack-knife. Furthermore, the front wheels of the tow vehicle can be too lightly loaded and cause loss of steering control and traction, if the front wheels are driving.

In addition to tow vehicle control, tongue weight is necessary to insure that the trailer axle(s) do not exceed their Gross Axle Weight Rating (GAWR).

The table in 1.2.10 gives recommended percentages.

4.2. CHECKING TONGUE WEIGHT

To check the tongue weight, the tow vehicle and trailer must be on level ground, as they will be when the trailer is being towed. Physically confirm that the trailer is level with a tape measure.

For lighter trailers the recommended method of checking tongue weight is to use an accessory called a “tongue weight scale.” If a tongue weight scale is not available from your dealer, call Pace American at 877-475-5665 for assistance.

An alternate method of checking tongue weight involves the use of a bathroom scale. The loaded trailer must be on a smooth and level surface, and you must block the trailer wheels, front and rear.

Bathroom Scale Method for Checking Tongue Weight

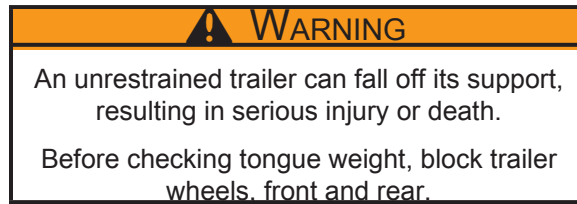

Raise the tongue of the trailer with the jack.

Place a bathroom scale on the ground, directly below the coupler.

Place a strong block support (such as a cement block) on the scale – note the scale reading for the weight of the block support.

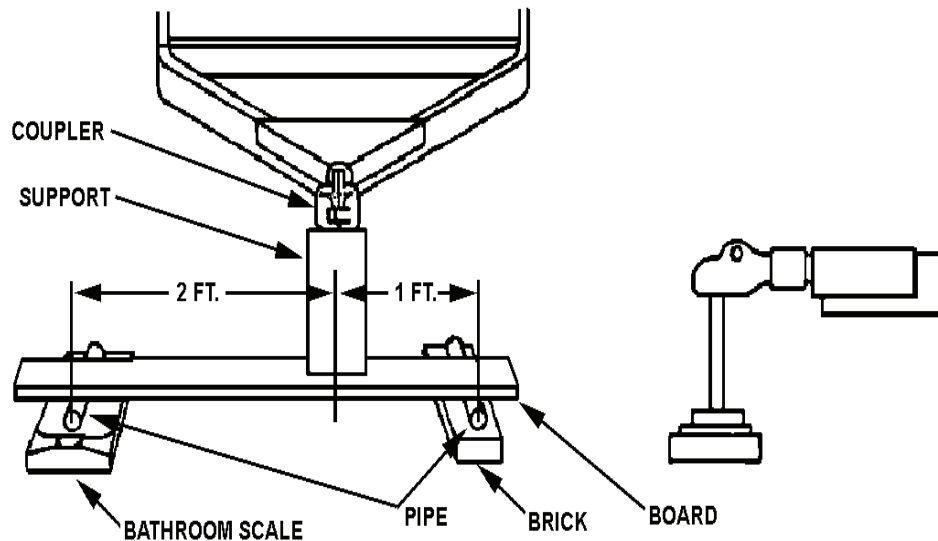

Lower the tongue until the coupler rests on the block support and the jack is $\frac{1}{2}$ inch above the ground. The scale reading, minus the weight of the block support is the tongue weight.

If the tongue weight exceeds the capacity of a bathroom scale, you can use “leverage” to divide the tongue weight between the bathroom scale and another support (see “Checking Tongue Weight” figure).

- Raise the tongue of the trailer with the jack.
- Arrange a brick, 2 x 4 (or 4 x 4) board, bathroom scale and pipes as shown in “Checking Tongue Weight” figure. The brick should be about the same thickness as the bathroom scale.
- Leave a 3 foot distance between the pipes, and place the coupler about 2 feet from the pipe on the bathroom scale.
- Place a strong block support (such as a cement block) on the board. Note the weight indicated on the scale.
- Lower the tongue until the coupler rests on the block support and the jack is $\frac{1}{2}$ inch above the ground.
- Subtract the scale reading with the block and board alone from the scale reading with the trailer on the block. Multiply the result by 3 to get the actual tongue weight.

Example:

Scale reading with block and board alone = 10 lbs.

Scale reading with trailer coupler resting on board = 50 lbs.

Actual tongue weight: $(50-10) \times 3 = 120$ lbs.

For heavier trailers it is easier to go to a truck stop where there is a “certified” scale. Pull only the tow vehicle onto the scale and get the weight. This weight must be less than your tow vehicle’s GVWR. Pull the trailer onto the scale and decouple it from the tow vehicle, leaving just the trailer on the scale. Get a “ticket”, which lists the total trailer weight. Re-connect the trailer to your tow vehicle and the drive the tow vehicle wheels off the scale, just

leaving the trailer axles on the scale. Get a second “ticket”, which lists the trailer’s axle weight. Simply subtract the axle weight from the total weight to determine the hitch weight.

While you are at the scale, you should weigh the entire combination vehicle. This result should be less than the Gross Combined Weight Rating (GCWR) for your towing vehicle. Some scales allow you to get individual axle weights also. If this is possible, get the tow vehicle’s front and rear axle weights to make sure they are in the same proportion as the tow vehicle alone, and that the rear axle is not overloaded. This is the best way to check that a weight distribution (or load leveling) hitch is adjusted properly, i.e., you have the proper number of chain links attached to the snap-up brackets.

4.3. SECURING THE CARGO

Since the trailer “ride” can be bumpy and rough, you must secure your cargo so that it does not shift while the trailer is being towed.

4.3.1. LOADING CARGO (ENCLOSED TRAILER)

Couple the trailer to the tow vehicle before loading. The tongue of a bumper pull trailer can rise during loading, before the cargo is properly distributed.

Lower the stabilizer jacks if equipped.

Do not transport people, containers of hazardous substances, cans or containers of flammable substances. However, fuel in the tank of an off-road vehicle, or a car or motorcycle, etc., may be carried inside of your enclosed cargo trailer.

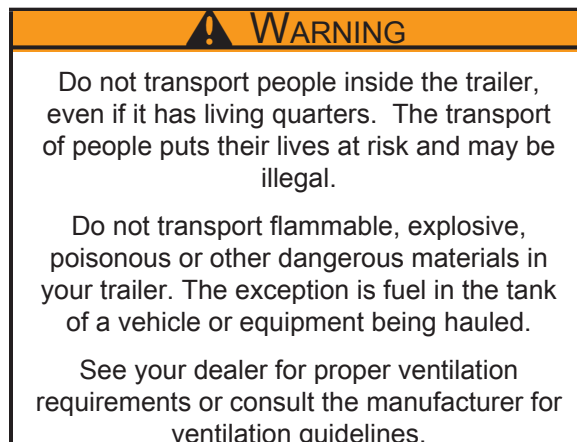

4.3.1.1. Preparing the Trailer for Loading

Before loading cargo into your enclosed trailer, inspect the interior of the trailer.

Enclosed trailers may be fitted with “D”-ring hold-downs, and/or a track system that can be used to secure the cargo. Inspect the “D”-rings and track system for looseness or signs of bending before loading the cargo onto the trailer.

4.3.1.2. Loading the Enclosed Trailer

Enclosed trailers may be fitted with a drop ramp door. The weight of the drop ramp door is partially held by a spring and cable counterbalance assembly. If the spring and cable counterbalance assembly is out of adjustment or worn out, it will not provide the expected assistance for slow and careful lowering and raising ramp.

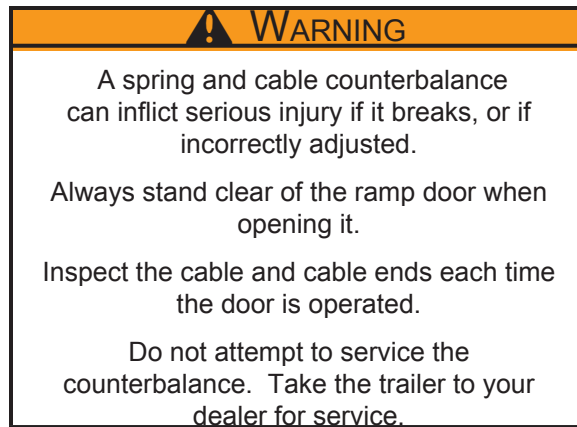

Carefully lower the drop ramp to the ground.

Load the cargo up the drop ramp and into the trailer, with approximately 60% of the cargo in the front half of the trailer. If the trailer has living quarters, the cargo area of your trailer will have ventilation openings near the floor. Do not block these ventilation openings. These openings are provided to exhaust potentially deadly fumes.

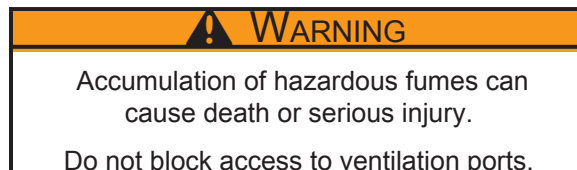

Secure the cargo to the trailer using appropriate straps, chains and tensioning devices.

Close the drop ramp door and secure the trailer door catch using a linchpin or other locking device, so that the catch and door cannot open while the trailer is being towed.

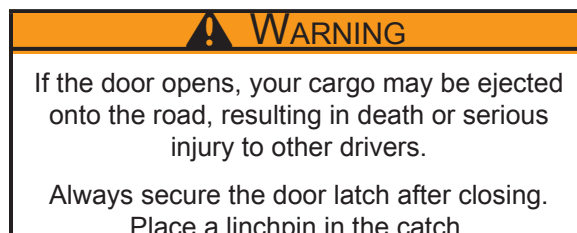

Return the stabilizer jacks (if equipped) to the retracted position.

5. CHECKING THE TRAILER BEFORE AND DURING EACH TOW

5.1. PRE-TOW CHECKLIST

Before towing, double-check all of these items: See section 8.1, “Inspection, Service & Maintenance Summary Charts,” for more information.

- Tires, wheels and lug nuts (see the “Major Hazards” section starting on page 1 of this manual)
- Tire Pressure. Inflate tire on trailer and tow vehicle to the pressure stated on the VIN / Certification label.
- Coupler secured and locked (see the “Coupling and Uncoupling the Trailer” section of this manual)
- Safety chains properly rigged to tow vehicle, not to hitch or ball (see the “Coupling to the Tow Vehicle” chapter of this manual)
- Test of lights: Tail, Stop, and Turn Lights
- Test trailer brakes.
- Safety breakaway switch cable fastened to tow vehicle, not to safety chains (see the “Coupling to the Tow Vehicle” chapter of this manual)
- Cargo properly loaded, balanced and tied down (see the “Loading the Trailer” chapter of this manual)
- Tongue weight and weight distribution set-up.
- Doors and gates latched and secured
- Fire extinguisher
- Flares and reflectors
- Tongue and stabilizer jacks in the retracted position

5.2. MAKE REGULAR STOPS

After each 50 miles, or one hour of towing, stop and check the following items:

- Coupler secured
- Safety chains are fastened and not dragging
- Cargo secured
- Cargo door latched and secured

6. BREAKING-IN A NEW TRAILER

6.1. RETIGHTEN LUG NUTS AT FIRST 10, 25 & 50 MILES

Wheel lugs can shift and settle quickly after being first assembled, and must be checked after the **first** 10, 25 and 50 miles of driving. Failure to perform this check may result in a wheel coming loose from the trailer, causing a crash leading to death or serious injury.

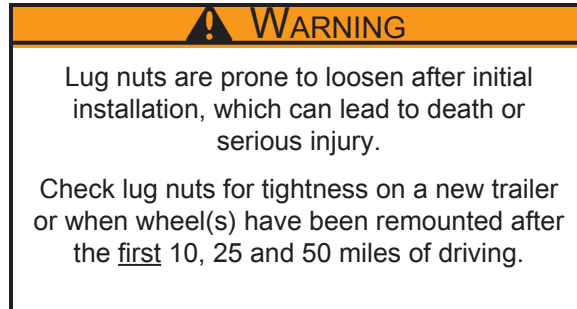

See Section 8.2.12.1 page 68 on Proper Touring Technique.

6.2. ADJUST BRAKE SHOES AT FIRST 200 MILES

Brake shoes and drums experience a rapid initial wear. The brakes must be adjusted after the first 200 miles of use, and each 3,000 miles thereafter. Some axles are fitted with a mechanism that will automatically adjust the brake shoes when the trailer is "hard braked" from a rearward direction. Read your axle and brake manual to see if your brakes adjust automatically. If you do not have the axle and brake manual, call Pace American at 877-475-5665 for a free copy.

A hard stop is used to:

- Confirm that the brakes work;
- Confirm that the trailer brakes are properly synchronized with the tow vehicle brakes using the brake controller in the tow vehicle
- Adjust the brake shoes as necessary.
- For surge brakes check the Master cylinder reservoir for fluid.

If your trailer is not fitted with automatically adjusting brakes, the brakes will need to be manually adjusted. See a Certified Service Center for Adjustment.

6.3. SYNCHRONIZING THE BRAKE SYSTEMS

Trailer brakes are designed to work in synchronization with the brakes on the tow vehicle. When the tow vehicle and trailer braking systems are synchronized, both braking systems contribute to slowing, and the tongue of the trailer will neither dive nor rise sharply.

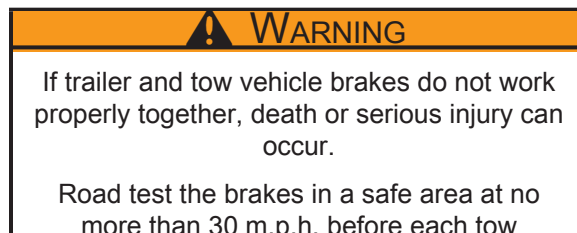

To insure safe brake performance and synchronization, read and follow the axle/brake and the brake controller manufacturers' instructions. If you do not have these instructions, call Pace American at 877-475-5665 for a free copy.

TIRE PRESSURE

Check tire pressures on both the trailer and tow vehicle. Inflate to the maximum shown on the VIN / Certification Label.

7. ACCESSORIES

This chapter provides some basic information for the safe operation of several accessories. For many accessories, such as generators and LP appliances, the manufacturer of the accessory has also provided instructions. You must read and follow these instructions before using the accessory. If you are uncertain whether you have all of the instructions, call Pace American at 877-475-5665 before operating the accessory.

The following accessories are described in this section:

- Gasoline (or LP) and Diesel Generators
- Accessory Battery
- “Shore Power” connections which provide power by “plugging the trailer in” to an external source of electrical power
- LP Gas Fuel System
- Vending or Accessory Doors
- Electric-powered Landing Gear

Many accessories introduce the risk of fire and carbon monoxide poisoning. If you have an accessory on your trailer, make sure you have a fire extinguisher charged and ready before operating the accessory. Check the fire extinguisher at least once a month. If the fire extinguisher is discharged even partially, it must be recharged. Follow the fire extinguisher manufacturer’s instructions for recharging the extinguisher after use.

7.1. GASOLINE-POWERED ELECTRIC GENERATORS

If your trailer is equipped with a generator, you must have and follow the generator manufacturer’s instructions. Carbon monoxide gas is present in the exhaust of all gasoline and diesel engines, as well as from other burning fuels such as LP gas and charcoal.

Carbon Monoxide is an odorless gas that can cause death. Be certain exhaust from any running engine or burning fuels can not accumulate in areas where people or animals are likely to be present. Conditions that can redirect exhaust fumes are, for example:

- Being drawn in by fans or ventilators operated in a trailer;
- Prevailing wind;
- Being trapped between adjacent trailers, vehicles or buildings; or
- Being trapped between or in a snow bank or other materials that can redirect fumes.

 **WARNING**

A cargo trailer is NOT intended to be slept in. If you upgrade or alter this trailer for sleeping purposes, it must be equipped with a carbon monoxide detector.

Carbon monoxide or other harmful vapors can enter through the floor openings.

Carbon monoxide can cause death or serious injury.

 **WARNING**

Operating gasoline and diesel generators can lead to death or serious injury by:

- Carbon Monoxide
- Fire and Explosion
- Electrocution

Have a working carbon monoxide detector in the accommodation spaces before operating a generator.

Do not refuel a running generator or refuel near ignition sources.

 **WARNING**

Do not operate portable heaters or generators inside an enclosed trailer without adequate ventilation as death or serious injury may occur.

Before starting the generator, check fuels and oil levels. The generator may have to run for two or three minutes before it allows drawing electricity from it. Read the generator instruction manual. If you do not have the generator instruction manual, call Pace American at 877-475-5665 for a free copy.

Never exceed the capacity of the generator.

Before turning off the generator, remove the electrical load and let the engine to run for two or three minutes to cool the generator.

7.2. ACCESSORY BATTERY

Your trailer may be outfitted with an accessory battery that operates lighting, electric landing gear, dump body, slide-outs or other accessories. An accessory battery may be kept charged either by the tow vehicle or by the generator or shore power.

A disconnect switch may be provided to disconnect the accessory battery when you do not plan to be using the trailer for an extended period, such as seasonal storage. If there is no disconnect switch, then remove the cables from the battery terminals.

The accessory battery must be kept in a charged condition during storage. The battery could freeze and break if it becomes discharged.

7.3. SHORE POWER

Shore power is the delivery of electrical power from another source to a power inlet on your trailer. To connect your trailer to this source, you must have a “shore power” cord, specifically designed for this use. **DO NOT USE AN ORDINARY EXTENSION CORD.** The trailer end of this cord is connected to an electrical box on the trailer, sometimes referred to as a “motor base.” This box contains circuit breakers and/or fuses and may include a power converter to change the shore power (usually 110 volts alternating current) into 12 volts direct current.

Do not assume that a shore power supply is correctly wired. Shore power may have incorrect polarity or not have the safety ground. Before connecting your trailer, you should test shore power by using a polarity and ground tester, which can be purchased at electronic stores.

If you have shore power, your trailer may be fitted with Ground-Fault Interrupting outlets (GFI). If you have GFI protection, you must periodically test the outlets by pressing the “TEST” button that is located on the GFI-equipped outlet.

⚠ WARNING

Shore power poses a risk of death due to electrocution or fire

- Always use an electrical cord specifically designed for shore power connection. Never use an ordinary extension cord.
- Always connect the electrical cord to a grounded source of shore power.
 - Do not remove the “third prong” from the shore power plug.
 - Connect only to source of proper voltage.
 - Make certain polarity is correct.
 - Do not overload electrical circuits.
- Always replace fuses or circuit breakers with correct rating.

7.4. **LP GAS FUEL SYSTEM**

LP gas systems are installed to operate a variety of appliances, such as stoves, refrigerators, heating units and electrical generators. The exhaust fumes from burning LP gas contain carbon monoxide. Carbon monoxide gas is odorless and can cause death or serious brain injury if inhaled. The exhaust from LP appliances must be directed to the outdoors. You must have an operating carbon monoxide detector in the living quarters of your trailer.

⚠ WARNING

You can die or be brain damaged by Carbon Monoxide.

Make certain the exhaust from LP appliances is directed to the outdoors.

Have a working carbon monoxide detector in the accommodation spaces of your trailer before operating any LP gas appliance.

Do not operate portable grills or stoves inside the trailer.

When used for the first time, or after a period of storage, the LP gas lines will be full of air and must be purged of air, before the appliances will stay lit. Have the LP gas lines purged by your trailer dealer, or an LP gas dealer.

An LP gas system is designed to operate with a supply of LP gas only, NOT natural gas. A natural gas supply is unsafe for the system’s pressure regulation devices.

⚠ WARNING

Risk of death due to fire or explosion.

Only connect an LP gas system to a supply of LP gas, NOT natural gas.

Do not store LP gas tanks inside the trailer.

Only fill an LP gas tank 80% full.

Only fill the tank with LP gas (butane or propane).

Overfilled tanks can release gas and cause an explosion.

Keep the shutoff valve on your LP gas tank closed at all times, except when you are operating an LP gas appliance. Before opening the LP shutoff valve, turn off all LP gas appliances. If an appliance is on when you open the shutoff valve, LP gas will accumulate in the trailer, which can result in an explosion.

Do not use a wrench to open or close the shutoff valve. If the shutoff does not completely stop the flow of LP gas

when it is hand-tightened, replace the shutoff valve.

LP gas leaks can result in fire or explosion. If your trailer is equipped with an LP gas system, it must also be equipped with an LP gas detector. The LP gas detector will be located near the floor to detect the heavier-than-air LP gas. If a leak is suspected, use a soapy water solution to search for the leak. Do not use a solution that contains ammonia or chlorine (common in window and other household cleaning compounds), because those chemicals will cause LP piping corrosion.

 **WARNING**

Risk of fire or explosion

If LP gas is detected (by smell or by the LP gas detector):

- Do not touch electrical switches
- Extinguish flames and pilot lights
 - Open doors for ventilation
- Shut off LP gas supply at the LP tank
- Leave the area until odor clears

Correct the source of LP gas leakage before using LP appliances.

Do not use a flame to locate the source of an LP gas leak.

LP gas is either propane or butane that is compressed into liquid form. LP gas must be completely vaporized before being burned. Butane gas will not operate if the outside temperature is below 32 degrees Fahrenheit.

 **NOTICE**

Use Butane only when the temperature is above freezing (32 degrees F).

Propane gas will operate at temperatures as low as minus 44 degrees Fahrenheit (-44 F).

Keep the regulator for the LP gas system (located near the LP gas tank) covered with a guard to protect it from road debris.

LP gas is prohibited on some roadways, bridges and tunnels. Check a map and with Departments of Transportation (or with the AAA) for travel routes that do not have such restrictions.

If you store your trailer, make sure that all appliances and generators are disabled prior to storing.

7.4.1. LP GAS SYSTEM TROUBLESHOOTING

Having liquid “gas” at your appliance is an indication that the LP gas tank is overfilled, or that the temperature is too cold.

If your LP gas appliances do not stay lit, it might be because your LP gas system is contaminated with air or moisture. Many LP gas vendors have facilities to purge the air from an LP gas system.

If your LP gas system is not providing gas, even when the shutoff valve is open, it might be because the LP gas regulator has frozen water in it.

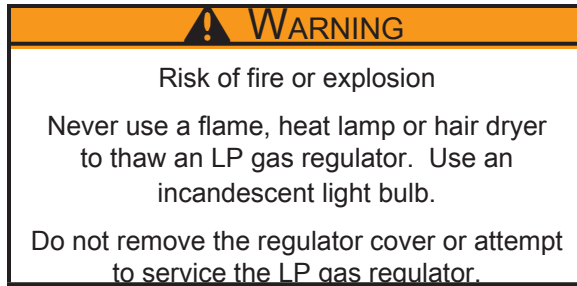

7.5. VENDING & ACCESSORY DOORS

A vending or accessory door opens vertically and has a hinge along its top edge. These heavy doors are equipped with spring-assisted lifting, usually with a device known as a “gas spring.” The gas spring lifting device is not designed to hold a vending door up. You must use the provided solid “prop rods” to hold a vending door in the open position.

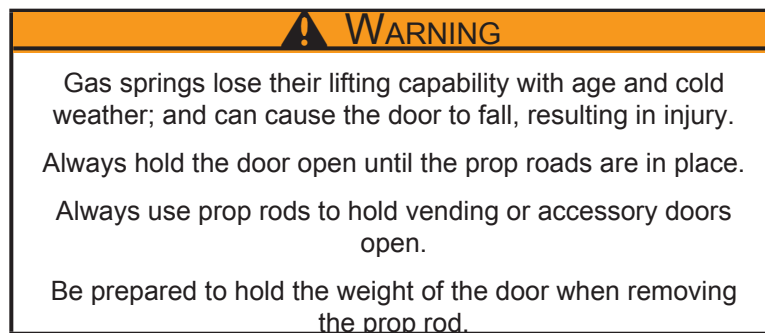

7.6. ELECTRIC-POWERED LANDING GEAR

The landing gear (also known as the jack) on your trailer may be powered with an electric motor. The landing gear is operated up or down using controls located near the landing gear.

If the motor does not operate, such as when the battery is fully discharged, the landing gear can be operated manually with a socket wrench

7.7. SPREAD AXLES

A wider wheelbase on a spread axle lends itself to a trailer that is harder to turn and less receptive to lateral inputs from the tow vehicle and more receptive to external factors. The trailer can start to “wander” with imperfect road conditions, strong winds, alignment issues, and air under the trailer.

If your trailer is equipped with spread axles (48” O.C.), the trailer must be 1-2” tongue high when hooked up to the tow vehicle. An anti-sway kit is also recommended for speeds in excess of 55MPH.

7.8. REFUELING STATION

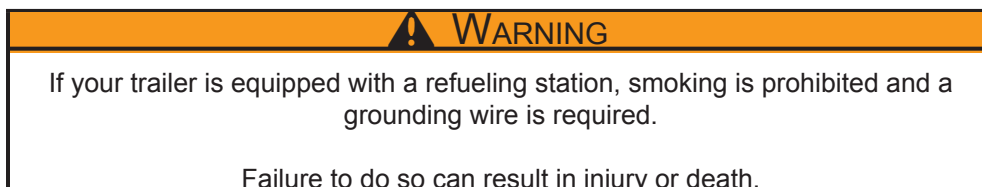

7.9. TRAILER ROOF

WARNING

Never climb on the roof of your trailer. Unless your trailer is specifically designed for this purpose, serious injury or death could occur.

8. INSPECTION, SERVICE & MAINTENANCE

8.1. INSPECTION, SERVICE & MAINTENANCE SUMMARY CHARTS

You must inspect, maintain and service your trailer regularly to insure safe and reliable operation. If you cannot or are unsure how to perform the items listed here, have your dealer do them. Note: In addition to this manual, also check the relevant component manufacturer's manual.

Inspection and Service before Each Use		
Item	Inspection / Service	Manual Section Reference
Breakaway Brakes > Electric > Hydraulic	Check operation Check fluid level	Sections 3.2.2.7, 3.2.3.4 & 3.2.4.3 Section 8.2.5.4
Breakaway Battery	Fully charged, connections clean	Sections 3.2.2.7, 3.2.3.4 & 3.2.4.3 Section 8.2.5.3.A.(i)
Brakes, all types	Check operation	Section 6.3
Shoes and Drums	Adjust	Section 6.2 8.2.5.2
Brakes, Hydraulic - Vacuum Actuated	Check gauge for proper vacuum of 18 In. Hg. (inches of mercury)	Section 8.2.5.4.A
Coupler and Hitch Ball	Check for cracks, pits, and flats. Replace w/ball & coupler having trailer GVW Rating. Grease. Check locking device & replace.	Section & 8.2.6.1
Gooseneck Ball	Check for cracks, pits, and flats. Replace w/ball & coupler having trailer GVW Rating. Grease. Check locking device & replace when worn.	Section 3.2.3.1 Section 3.2.3.1 Section & 8.2.6.2
Fifth Wheel & Kingpin	Check for cracks, Grease. Check locking device & replace when worn.	Section 3.2.4.1 Section 3.2.4.1 Section 3.2.4.1 & 8.2.6.3
Safety Chain(s) & Hooks	Check for wear and damage	Sections 0 & 3.2.3.3
Tires	Check tire pressure when cold. Inflate as needed.	Sections 5.1 & 8.2.10
Wheels - Lug Nuts (Bolts) & Hub	Check for tightness Tighten. For new and remounted wheels, check torque after first 10, 25 & 50 miles of driving and after any impact	Section 5.1 Sections 6.1 & 8.2.12.1

Inspection and Service each 3 Months or 3,000 Miles		
Item	Inspection / Service	Manual Section Reference
Structure > Rubber mats and floor > Hinges, Doors	Inspect. Repair or replace damaged, worn or broken parts	Section 8.2.2 Sections 8.2.2

Inspection and Service each 6 Months or 6,000 Miles		
Item	Inspection / Service	Manual Section Reference
Tires	Rotate @ 5,000 miles	Section 8.2.10
Brakes, electric > Magnets > Controller (in tow vehicle)	Check wear and current draw Check power output (amperage) and modulation	Section 8.2.5.3.C Section 8.2.5.3.B See Controller Mfr's Manual
Structure > Roof Vents > Windows	Clean dirt buildup, lubricate hinges and slides	Section 8.2.2
Tires	Inspect tread and sidewalls thoroughly. Replace tire when treads are worn, when sidewall has a bulge, or sidewall is worn	Section 8.2.10 Section 8.2.10

Inspection and Service Each Year or 12,000 Miles		
Item	Inspection / Service	Manual Section Reference
Brakes, all types > Shoes and drums	Check for scoring and wear. Replace per manufacturer's specifications	Section 8.2.5.1 See Brake Mfr's Manual
Jack, Drop-leg	Grease gears at top	See Jack Mfr's Manual
Structure > Frame members > Welds > Slide-out	Inspect all frame members, bolts & rivets. Repair or replace damaged, worn or broken parts. Inspect all welds. Repair as needed Clean dirt build-up. Lubricate slides, shafts and gears	Section 8.2.1 Section 8.2.2.2 Section 8.2.4
Wheels > Sealed Bearings (Hubs) > Rims	Check and confirm free running. Replace if not (sealed bearings are not serviceable) Inspect for cracks & dents. Replace as needed.	Section 8.2.12 Section 8.2.11
Structure > Axle Attachment Bolts	Check BY DEALER	Section 8.2.1

8.2. INSPECTION AND SERVICE INSTRUCTIONS

8.2.1. AXLE BOLTS, FRAME, SUSPENSION, & STRUCTURE

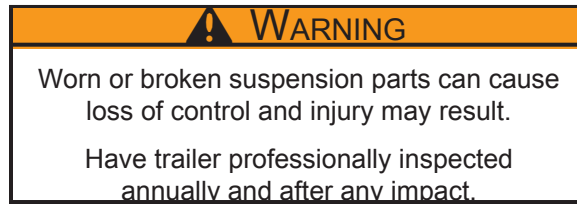

To perform many of the inspection and maintenance activities, crawl under the trailer.



8.2.2. TRAILER STRUCTURE

Because the trailer floor receives the most abuse, it will most likely corrode before any other part of the structure.

8.2.2.1. Fasteners and Frame Members

Inspect all of the fasteners and structural frame members for bending and other damage, cracks, or failure. Repair or replace any damaged fastener and repair the frame member. If you have any questions about the condition or method of repair of fasteners or frame members, get the recommendation of, or have the repair done by, your dealer.

The various fastener types used on your trailer are:

- Bolts, which are used mainly for attaching door and gate hinges to the trailer body;
- Buck Rivets, which are used to attach the sides and roof panels of the body to each other, and to the frame of the trailer; and
- Huck Bolts may be at various locations on the sub-frame. Huck bolts are not user serviceable. If you detect a loose huck bolt fastener, do not tow the trailer. Call your dealer for instructions.



8.2.2.2. Welds

All welds can crack or fail when subjected to heavy loads or movement of cargo that was not properly tied to prevent movement. Any time that you know or suspect that the trailer has been subjected to heavy loads or movement of cargo, immediately inspect the welds and fasteners for damage. To prevent severe damage to your trailer, inspect all of the welds for cracks or failure at least once a year.



8.2.3. DROP RAMP TORSION SPRINGS

If your trailer has a drop-ramp door, the weight of the door may be partially held by a torsion spring and a cable. Stand to the side when opening the drop ramp. You could be hurt if you are behind the drop ramp and the counterbalance does not work.

Inspect the cable and cable ends regularly for fraying and signs of loosening. If released, a torsion spring can inflict serious injury.

The torsion spring and cable are not user serviceable. The torsion spring must be serviced by a person who is trained in torsion spring safety.

8.2.4. SLIDE-OUTS

The optional slide-out facility is fitted with shafts, bushing, gears and sliding members located on the underside of the trailer. These parts are exposed to road grime, water and possible salt spray. Clean and lubricate the moving parts regularly to keep the slide-out from seizing.

Follow the instructions below to clean and lubricate the slide-out mechanism at least once per season, and more frequently if your trailer is operated in dusty or salt-spray environments.

- Clean the locations where the drive shaft passes through the bushings.
- Hand pack grease on the gears.
- Grease the sliding track.

8.2.5. TRAILER BRAKES

8.2.5.1. Brake Shoes and Drums

Properly functioning brake shoes and drums are essential to ensure safety. You must have your dealer inspect these components at least once per year, or each 12,000 miles.

The brake shoes must be adjusted after the first 200 miles of use, and each 3,000 miles thereafter. Most axles are fitted with a brake mechanism that will automatically adjust the brake shoes when the trailer is “hard braked” from a rearward direction. Read your axle and brake manual to see how to adjust your brakes. If you do not have this manual, call Pace American at 877-475-5665 for a free copy.

8.2.5.2. Manually Adjusting Brake Shoes

Most braking systems are not automatically adjusted by hard stopping. These brakes require manual adjustment. If you are not a certified brake specialist call your dealer to locate a service center with certified brake specialists.

8.2.5.3. Brakes, Electric

Two different types of electric brakes may be present on the trailer: an emergency electric breakaway system, which acts only if the trailer comes loose from the hitch and the breakaway pin is pulled. The other brake is an electric braking system that acts whenever the brakes of the tow vehicle are applied.

8.2.5.3.A. BREAKAWAY BRAKE

8.2.5.3.A. (I) BREAKAWAY BATTERY

This battery supplies the power to operate the trailer brakes if the trailer uncouples from the tow vehicle. Be sure to check, maintain and replace the battery according to the battery manufacturer's instructions.

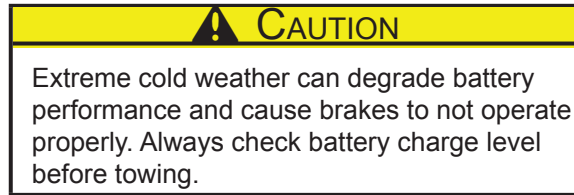

8.2.5.3.A. (II) BREAKAWAY SWITCH

This switch causes the breakaway battery to operate the electric brakes if the trailer uncouples from the tow vehicle.

The pull cable for the pull pin is connected to the tow vehicle, and the switch is connected to the trailer. To check for proper functioning of the switch, battery and brakes, you must pull the pin from the switch and confirm that the brakes apply to each wheel. You can do this by trying to pull the trailer with the tow vehicle, after pulling the pin. The trailer brakes may not lock, but you will notice that a greater force is needed to pull the trailer.

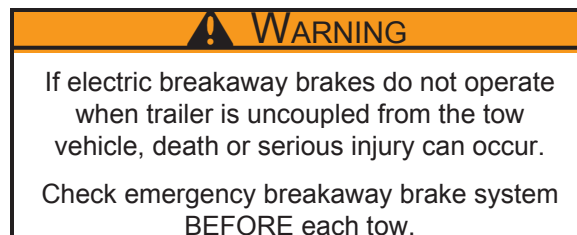

8.2.5.3.B. TOW VEHICLE OPERATED ELECTRIC BRAKES

The electric brakes that operate in conjunction with the tow vehicle brakes must be "synchronized" so that braking is properly distributed to the tow vehicle brakes and the trailer brakes. For proper operation and synchronization, read and follow the axle/brake and the brake controller manufacturers' instructions. If you do not have these instructions, call Pace American at 877-475-5665 for a free copy.

8.2.5.3.C. MAGNETS FOR ALL ELECTRIC BRAKES

To make certain an electrically-operated braking system will function properly, you must have your dealer inspect the magnets at least once a year, or each 12,000 miles. See the brake manual for wear and current inspection instructions.

8.2.5.4. **Brakes, Hydraulic (vacuum, air or electric operated)**

If your trailer has hydraulically-operated brakes, they function the same way the hydraulic brakes do on your tow vehicle. The hydraulic braking system must be inspected by a dealer, at least as often as the brakes on the tow vehicle, but no less than once per year. This inspection includes an assessment of the condition and proper operation of the wheel cylinders, brake shoes, brake drums and hubs.

You must check the fluid level in the master cylinder reservoir at least every three months. If you tow your trailer an average of 1,000 miles per month in a hot and dry environment, you must check the brake fluid level once a month. The brake fluid reservoir is located on the tongue of the trailer or near the gooseneck. Fill with DOT 4 brake fluid.

8.2.5.4.A. VACUUM-OPERATED HYDRAULIC

When towing a trailer, the vacuum gauge, which is located inside the cab of the tow vehicle, must indicate 18 In. Hg. (inches of mercury) or more at all times.

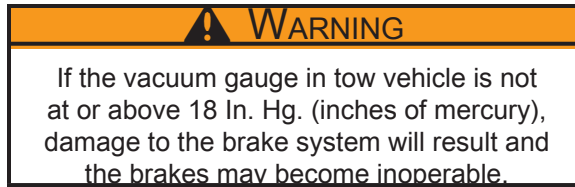

8.2.5.4.B. AIR PRESSURE-OPERATED HYDRAULIC

Air/hydraulic braking systems are typically used when the tow vehicle has a diesel engine. The tow vehicle has an air compressor that routes the air to an air/hydraulic mechanism, which sends brake fluid to the wheel cylinders.

8.2.5.4.C. ELECTRICAL-OPERATED HYDRAULIC

Electric/hydraulic braking systems, which are mounted on the trailer, use a small electrically-driven pump to generate hydraulic pressure, which operates the brake cylinders. Like electrical brakes, an electric/hydraulic braking system is operated by an electrical signal from the tow vehicle.

8.2.6. TRAILER CONNECTION TO TOW VEHICLE

8.2.6.1. Coupler and Ball

The coupler on the trailer connects to the ball attached to the hitch on the tow vehicle. The coupler, ball and hitch transfer the towing forces between the tow vehicle and the trailer. Before each tow, coat the ball with a thin layer of automotive bearing grease to reduce wear and ensure proper operation; and check the locking device that secures the coupler to the ball for proper operation.

If you see or feel evidence of wear, such as flat spots, deformations, pitting or corrosion, on the ball or coupler, immediately have your dealer inspect them to determine the proper action to prevent possible failure of the ball and coupler system. All bent or broken coupler parts must be replaced before towing the trailer.

The coupler handle lever must be able to rotate freely and automatically snap into the latched position. Oil the pivot points, sliding surfaces, and spring ends with SAE 30W motor oil. Keep the ball pocket and latch mechanism clean. Dirt or contamination can prevent proper operation of the latching mechanism.

When replacing a ball, the load rating must match or exceed the GVWR of the trailer.

8.2.6.2. Gooseneck

The gooseneck receiver on the trailer connects to a hitch-mounted ball on the towing vehicle. The receiver, ball and hitch transfer the towing forces between the tow vehicle and the trailer. Before each tow, coat the ball with a thin layer of automotive bearing grease to reduce wear and ensure proper operation; and check the locking device that secures the receiver to the ball for proper operation.

If you see or can feel evidence of wear, such as flat spots, pitting or corrosion, on the ball or receiver, immediately have your dealer inspect them to determine the proper action to prevent possible failure of the ball and receiver system.

When replacing a ball, the load rating must match or exceed the GVWR of the trailer.

8.2.6.3. Fifth Wheel Kingpin

Before each tow, inspect the fifth wheel and kingpin for wear, and coat the contact surface of the fifth wheel plate with water-resistant Lithium-base grease. If you see evidence of wear on the fifth wheel or kingpin, immediately have your dealer inspect them to determine the proper action to prevent failure of the fifth wheel and kingpin system.

8.2.7. LANDING LEG OR JACK

If a grease fitting is present, you must use a grease gun to lubricate the jack mechanism. Grease the gears in the top of hand-cranked jacks once a year, by removing the top of the jack and pumping or hand packing grease into the gears.

8.2.8. LIGHTS AND SIGNALS

Before each tow, check the trailer taillights, stoplights, turn signals and any clearance lights for proper operation.



8.2.9. ACCESSORY BATTERY

Your trailer may be outfitted with an accessory battery that operates lighting, electric landing gear, slide-outs or other accessories. An accessory battery may be kept charged either by the tow vehicle or by the generator or shore power. See the manual for the accessory battery.

A disconnect switch may be provided to disconnect the accessory battery when you do not plan to be using the trailer for an extended period, such as seasonal storage. If there is no disconnect switch, then remove the cables from the battery terminals.

The accessory battery must be kept in a charged condition during storage. The battery could freeze and break if it becomes discharged.

8.2.10. TIRES

Trailer tires may be worn out even though they still have plenty of tread left. This is because trailer tires have to carry a lot of weight all the time, even when not in use. It is actually better for the tire to be rolling down the road than to be idle. During use, the tire releases lubricants that are beneficial to tire life. Using the trailer tires often also helps prevent flat spots from developing.

The main cause of tire failure is improper inflation. Check the cold tire inflation pressures at least once a week for proper inflation levels. "Cold" means that the tires are at the same temperature as the surrounding air, such as when the vehicle has been parked overnight. Wheel and tire manufacturers recommend adjusting the air pressure to the trailer manufacturer's recommended cold inflation pressure, in pounds per square inch (PSI) stated on the vehicle's Federal Certification Label or Tire Placard when the trailer is loaded to its gross vehicle weight rating (GVWR). If the tires are inflated to less than the recommended inflation level or the GVWR of the trailer is exceeded, the load carrying capacity of the tire could be dramatically affected. If the tires are inflated more than the recommended inflation level, handling characteristics of the tow vehicle/trailer combination could be affected. Refer to the owner's manual or talk to your dealer or vehicle manufacturer if you have any questions regarding proper inflation practices.

Tires can lose air over a period of time. In fact, tires can lose 1 to 3 PSI per month. This is because molecules of air, under pressure, weave their way from the inside of the tire, through the rubber, to the outside. A drop in tire pressure could cause the tire to become overloaded, leading to excessive heat build up. If a trailer tire is under-inflated, even for a short period of time, the tire could suffer internal damage.

High speed towing in hot conditions degrades trailer tires significantly. As heat builds up during driving, the tire's internal structure starts to breakdown, compromising the strength of the tire. It is recommended to drive at moderate speeds.

After three years, replacing the trailer tires with new ones should be considered, even if the tires have adequate tread depth. It is best to have your tires inspected by a tire supplier to determine if your tires need to be replaced.

If you are storing your trailer for an extended period, make sure the tires are fully inflated to the maximum rated pressure and that you store them in a cool, dry place, such as a garage. Use tire covers to protect the trailer tires from the harsh effects of the sun.

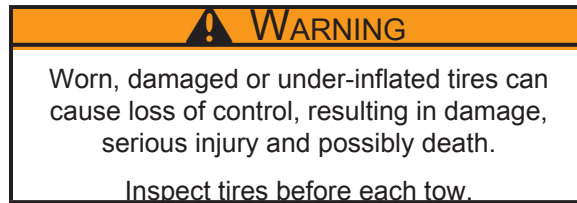

8.2.11. WHEEL RIMS

If the trailer has been struck, or impacted, on or near the wheels, or if the trailer has struck a curb, inspect the rims for damage (i.e. being out of round); and replace any damaged wheel. Inspect the wheels for damage every year, even if no obvious impact has occurred.

8.2.12. WHEELS, BEARINGS AND LUG NUTS

A loose, worn or damaged wheel bearing is the most common cause of brakes that grab.

To check your bearings, jack trailer and check wheels for side-to-side looseness. If the wheels are loose, or spin with a wobble, the bearings must be serviced or replaced.

Most trailer axles are built with sealed bearings that are not serviceable. Sealed bearings must be replaced as complete units.

8.2.12.1. Lug Nuts (Bolts)

Being sure wheel mounting nuts (lug nuts) on trailer wheels are tight and properly torqued is an important responsibility that trailer owners and users need to be familiar with and practice. Inadequate and/or inappropriate wheel nut torque (tightness) is a major reason that lug nuts loosen in service. Loose lug nuts can rapidly lead to a wheel separation with potentially serious safety consequences.

Lug nuts are prone to loosen right after a wheel is mounted to a hub. When driving on a new or remounted wheel, check the lug nut tightness often during the first few hundred miles of the trailer's use, especially after the first 10, 25 and 50 miles of driving, before each tow, and at least twice per year thereafter.

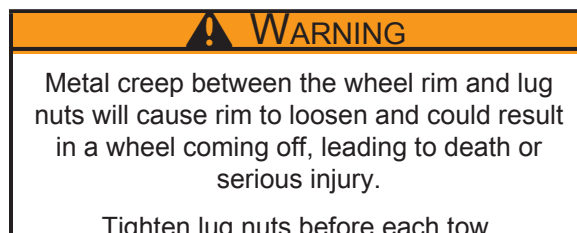
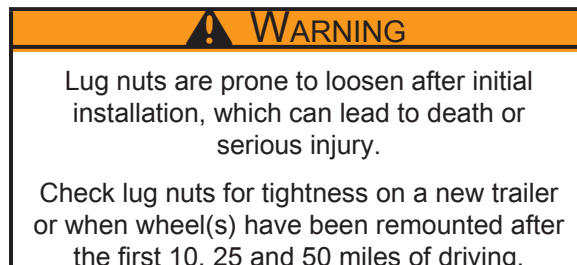

Tighten the lug nuts to the proper torque for the axle size on your trailer to prevent wheels from coming loose. Use a torque wrench to tighten the fasteners. The only way to be certain you have checked the torque or torqued the lug nuts to the proper torque is with a torque wrench. Four-way wrenches, ratchets, and similar tools can be useful for short-term emergency repairs, but are not appropriate tools for adequately checking lug nut torque. You must use a torque wrench to adequately indicate the torque that you are applying to the lug nut. If you do not have a torque wrench, tighten the fasteners with a lug wrench as much as you can, then have a service garage or dealer tighten the lug nuts to the proper torque. Over-tightening will result in breaking the studs or permanently deforming the mounting stud holes in the wheels.

Keep a record of the date and approximate mileage when you check the lug nut torque. Note any lug nut that has lost torque. Investigate the reason(s) if the lug nut torque is not maintained after more than one re-torque application, because this indicates there is something wrong with the lug nuts, nut studs, wheels and/or hubs and should be corrected.

Contact your dealer or vehicle manufacturer immediately if you experience any persistent lug nut loosening or any other lug, wheel or axle problems.

In the event of a wheel separation incident, notify the vehicle manufacturer and dealer. Seek prompt professional assistance in assessing the trailer and its gear, and retain, but don't re-use involved lugs, wheels and studs. Don't repair or service the trailer yourself. Call a trained technician.

Dry Torque Foot-pounds is determined by manufacturer.

Size	Bolt Circle	Off Set	Recommended Torque (ftlbs)	
			Steel	Aluminum
12"	4-4 or 5-4.5	0.00	50-75	95-105
13"	4-4 or 5-4.5	0.00	50-75	95-105
14"	5-4.5	0.00	90-120	110-120
15"	5-4.5	0.00	90-120	110-120
15"	6-5.5	0.00	90-120	110-120
16" (1/2" Stud)	6-5.5	0.00	90-120	110-120
16" (9/16" Stud)	8-6.5	0.00	90-120	125-130
17.5" (9/16" Stud)	8-6.5	0.00	275-325	125-130
17.5" (5/8" Stud)	8-6.5	0.00	275-325 (Flange Nut)	150

Lug Nut Installation Sequence(s)

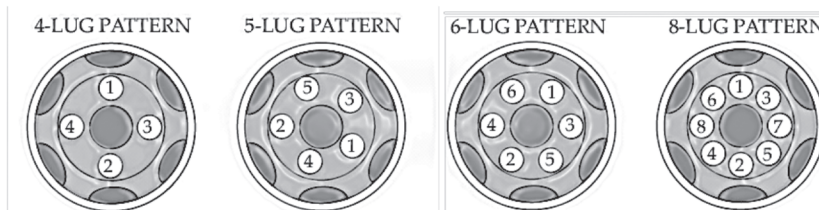

Wheel Torque

Using a properly calibrated torque wrench, all the lug nuts installed with any new tire/wheel assembly must have their torque values checked after the first 25, 50, and 75 miles (and periodically checked during normal use). This process should be repeated any time that the lug nuts are removed from the wheel.